

## **VARIO GT 24**

The variable Girder Wall Formwork System  
with the proven Lattice Girder GT 24

Product Brochure – Issue 11/2017

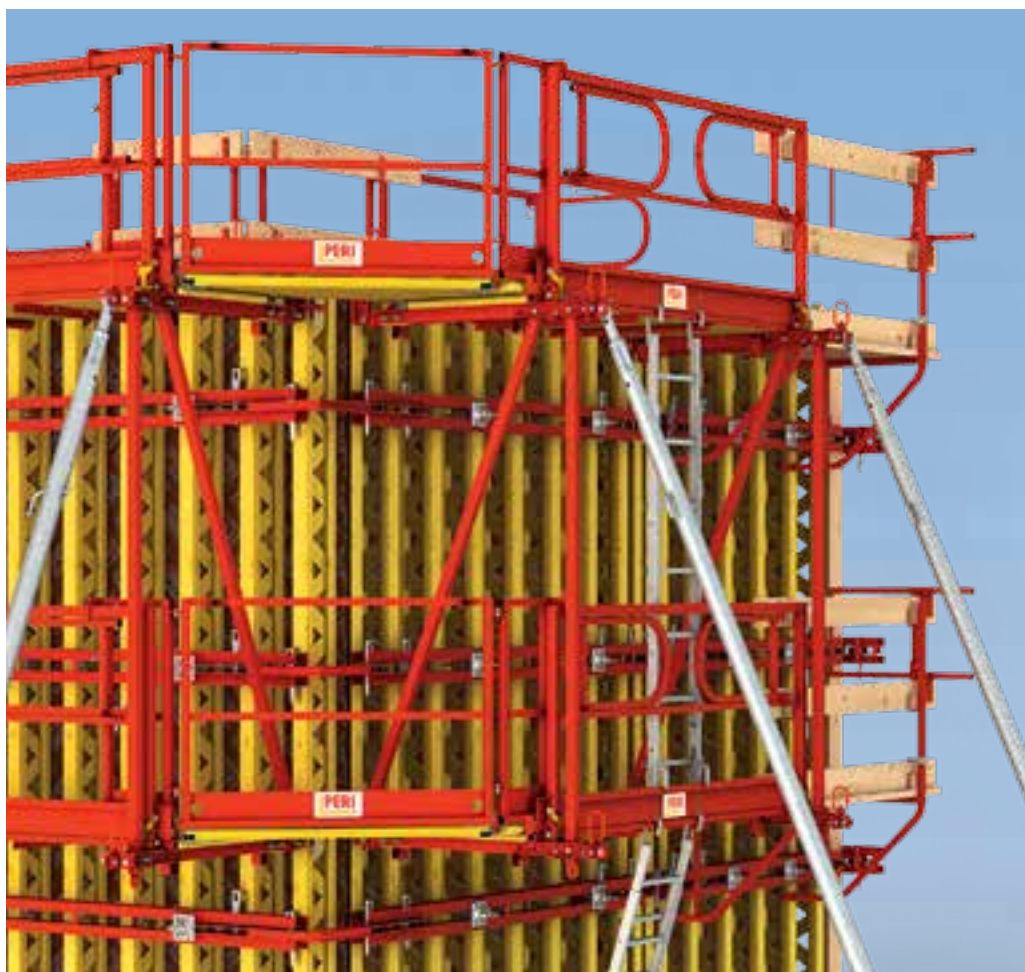

**PERI GmbH**  
**Formwork Scaffolding Engineering**

Rudolf-Diesel-Strasse 19  
89264 Weissenhorn  
Germany  
Tel. +49 (0) 7309.950-0  
Fax +49 (0) 7309.951-0  
info@peri.com  
www.peri.com

**Important Notes**

All current safety regulations and guidelines must be observed in those countries where our products are used.

The photos shown in this brochure feature construction sites in progress. For this reason, safety and anchor details in particular cannot always be considered as conclusive or final. These are subject to the risk assessment carried out by the contractor.

In addition, computer graphics are used which are to be understood as system representations. For ensuring a better understanding, these and the detailed illustrations shown have been partially reduced to certain aspects. The safety installations which have possibly not been shown in these detailed descriptions must nevertheless be available.

The systems or items shown might not be available in every country.

Safety instructions and load specifications are to be strictly observed at all times. Separate structural calculations are required in case of changes and deviations.

The information contained herein is subject to technical changes in the interests of progress. Errors and typographical mistakes reserved.

# Content

## **General**

- 2 The variable girder wall formwork system
- 6 Complicated geometries with standard system components
- 8 The GT 24 lattice girder
- 10 The standard system components of a VARIO GT 24 panel

## **Standard Applications**

- 12 VARIO GT 24 standard panels
- 14 Continuously adjustable panel connections
- 16 Fillers, stopend formwork and panel width extension units
- 18 External corners, internal corners and shafts
- 20 Push-pull prop connector, crane lifting units
- 22 Working and Concreting Scaffold
- 24 Panel extensions

## **Special applications**

- 26 Architectural concrete
- 30 Bridge construction
- 34 Water-retaining structures
- 38 Single-sided walls

- 40 Components

# General

## The variable girder wall formwork system

**VARIO GT 24 is the proven girder wall formwork system complete with the continuously adjustable elongated hole couplings.**

Regardless whether it is industrial or residential construction, bridge abutments or retaining walls, every layout and any height up to 18 m can be formed with PERI VARIO.

The 30 cm increments of the GT 24 girder allow easy adjustment to suit the required height.

Pre-assembled, ready-to-use platforms provide site personnel with a very high level of safety, as well as large time savings particularly with multiple usage.





Extended VARIO GT 24 panels being used to shutter administration building.



VARIO GT 24 being used to build a sewage treatment facility with tapered walls.

**The VARIO GT 24 girder wall formwork system offers many advantages. This includes simple planning, minimum on-site material requirements and fast, efficient formwork sequencing.**

Optimally-sized large elements can be assembled specifically for every project. In the process, the following points can always be freely selected:

- type and size of the formlining
- formlining fixings
- panel widths and heights
- position of any height extension or reduction
- girder length and spacing
- waler position, profile and length
- permissible fresh concrete pressure
- tie arrangement (horizontal, vertical)
- type of panel (straight, curved, offset)

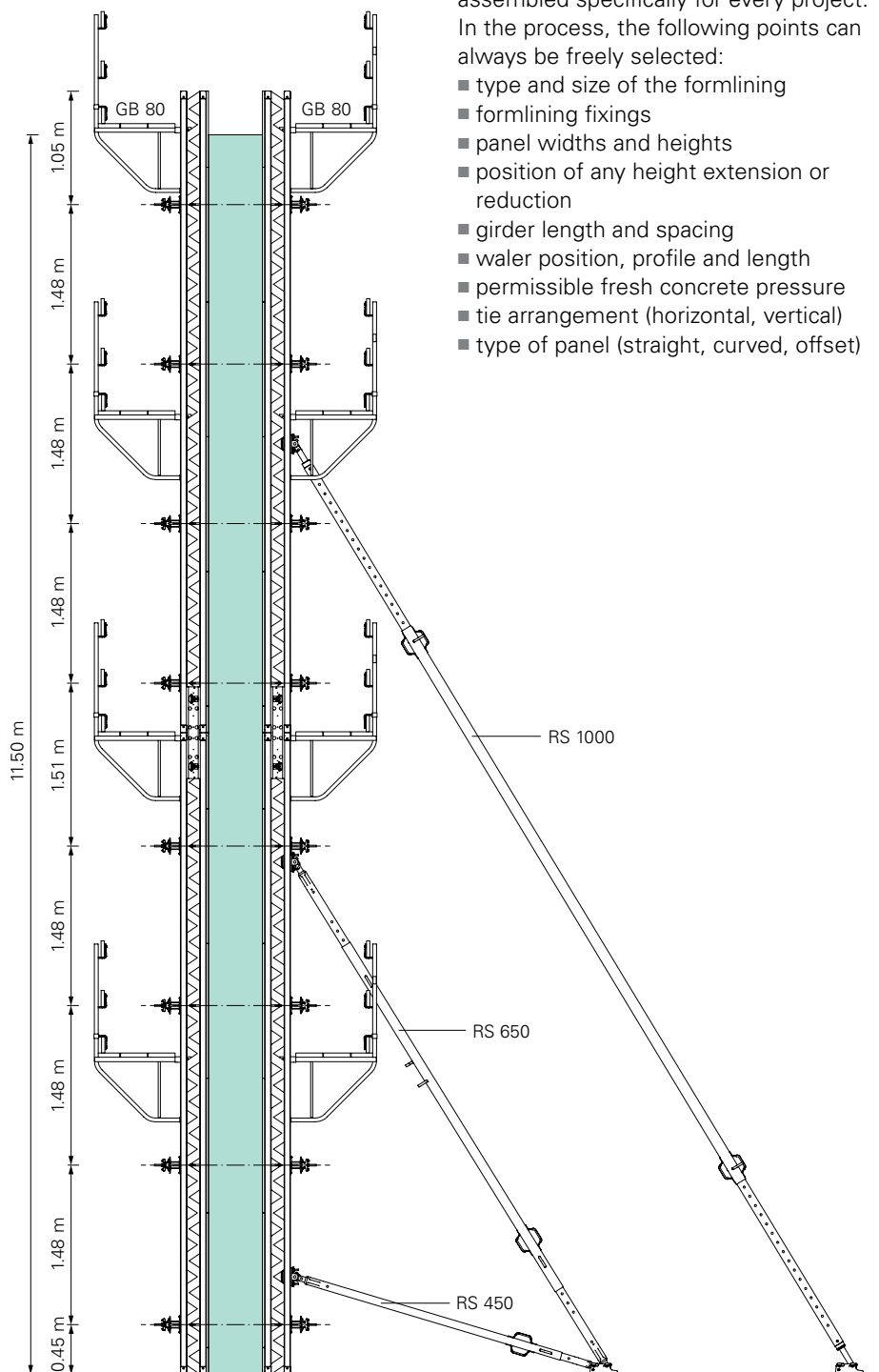

# General

## The variable girder wall formwork system



### The formwork is extended with the VARIO Extension Splice 24.

Quickly and easily fitted through the latticework of the GT 24, without having to drill girders.

The flexural rigid connection automatically aligns the girders. The splice consists of just two components which are quickly connected using triple wingnuts.

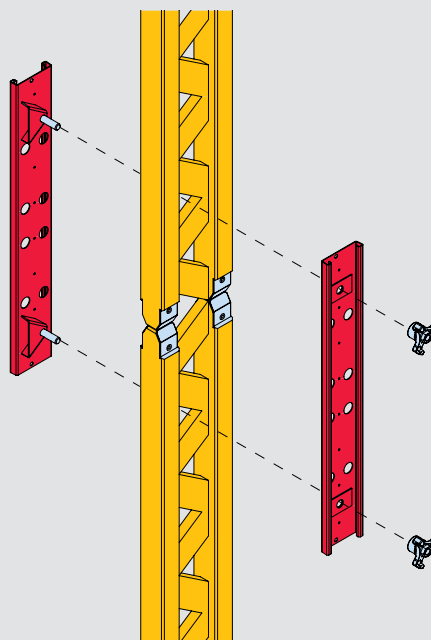

VARIO GT 24 formwork specially adapted to the requirements with defined formlining joint formation and tie point positioning.



VARIO GT 24 on the RCS rail climbing system for constructing the elevator and stairway shafts of a highrise building.

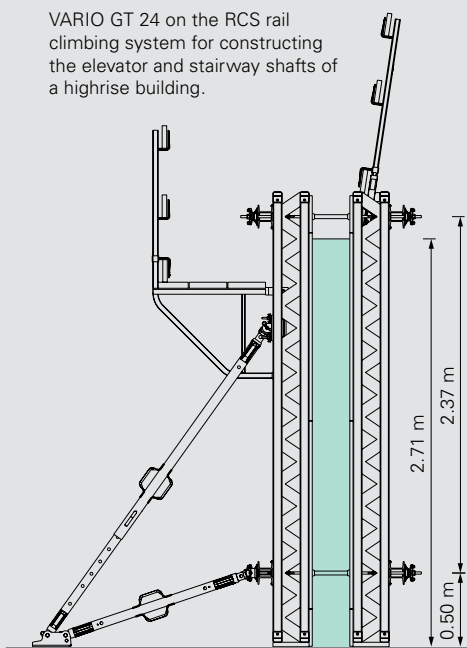

VARIO panels, with concreting scaffold and push-pull props, are shifted as a complete unit.



Soundproof sealing of the tie points costs 50% less as the top tie point is above the concrete with a spacing of 2.37 m.

# General

## Complicated geometries with standard system components



14 m high VARIO elements were arranged polygonally in the curved areas. With large-sized Fin-Ply Maxi plywood as formlining, an excellent concrete surface quality could be achieved.



VARIO GT 24 being used to construct a circular tank. Timber wedges between girders and steel walers produce the circular shape.

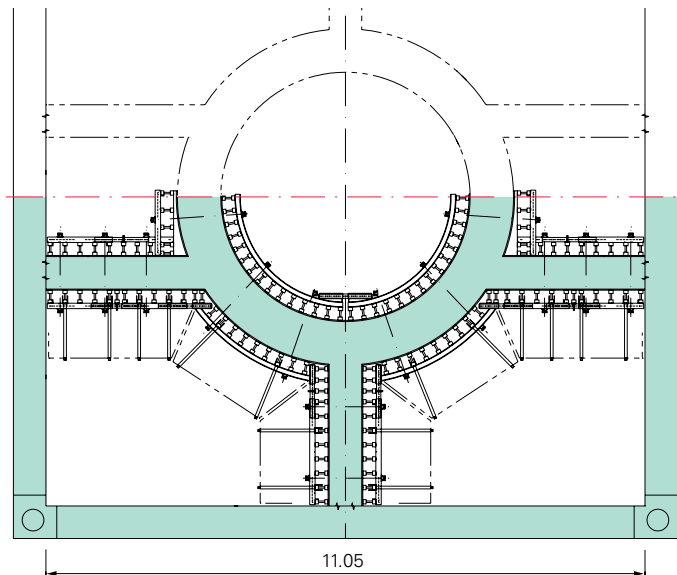

Even for this complicated layout, over 90% of the formwork consists of standard system components.



Multi-storey building in Paris with VARIO GT 24 and CB 240 climbing formwork systems.

The stringent French safety standards for high-rise construction were taken into account during the formwork planning. They included fine wire mesh panels for all safety handrails, and end handrail swing frames for the outside climbing units, in order to maximise the protection against falling, even during climbing.

# General

## The GT 24 lattice girder

As the main component in slab and wall formwork, the formwork girder significantly determines the profitability of the formwork. Thereby, it is not the initial investment costs but the durability and handling costs which are the decisive factors.

**Therefore, successful contractors use the GT 24 lattice girder from PERI:**

- light and manageable for slabs
- strong for wall formwork
- cost-effective for customized formwork solutions

**The GT 24 from PERI offers:**

- long service life
- shorter forming times



More information is available in the GT 24 brochure.



**Designed by timber specialists to ensure a long service life**

The patented girder nodes with mini-finger joints has virtually no "water cavities" which could trap moisture. The latticework design ensures excellent air circulation even when the girders are stacked.



The GT 24 in comparison	VT 20	GT 24	Diff. %
Permissible reaction force	22 kN	28 kN*	+ 27%
Permissible bending moment	5 kNm	7 kNm*	+ 40%
Flexural stiffness	460 kNm <sup>2</sup>	887 kNm <sup>2</sup>	+ 86%
Weight	5.3 kg/m	5.9 kg/m	±0%

\* When supported at the nodes.

**High load-bearing capacity with low weight**

Perm. Q on the compression struts  $Q_D = 14 \text{ kN}$   
 Perm. bending moment  $M = 7 \text{ kNm}$   
 $I_y = 8.064 \text{ cm}^4$

**Steel end caps with through-rivets**

- Robust end protection
- Prevents end being sawn off accidentally
- Can be used to replace the rubbing board on VARIO panels if required

**6 x 8 cm thick chord**

For easy screwing and nailing. The girder chord is prevented from splitting as the full depth of the chord is finger-jointed to the struts and tied at each girder connection.

PERI Design Tables are available for slab and wall formwork operations. The girder is monitored according to the requirements of DIN EN 13377.



**The GT 24 lattice girder –**  
 the girder that reduces  
 your shuttering costs!

# General

## The standard system components of a VARIO GT 24 panel

### The GT 24 formwork girder

forms the main element of the VARIO GT 24 wall formwork. Available in lengths from 90 cm to 17.80 m, in 30 cm increments.

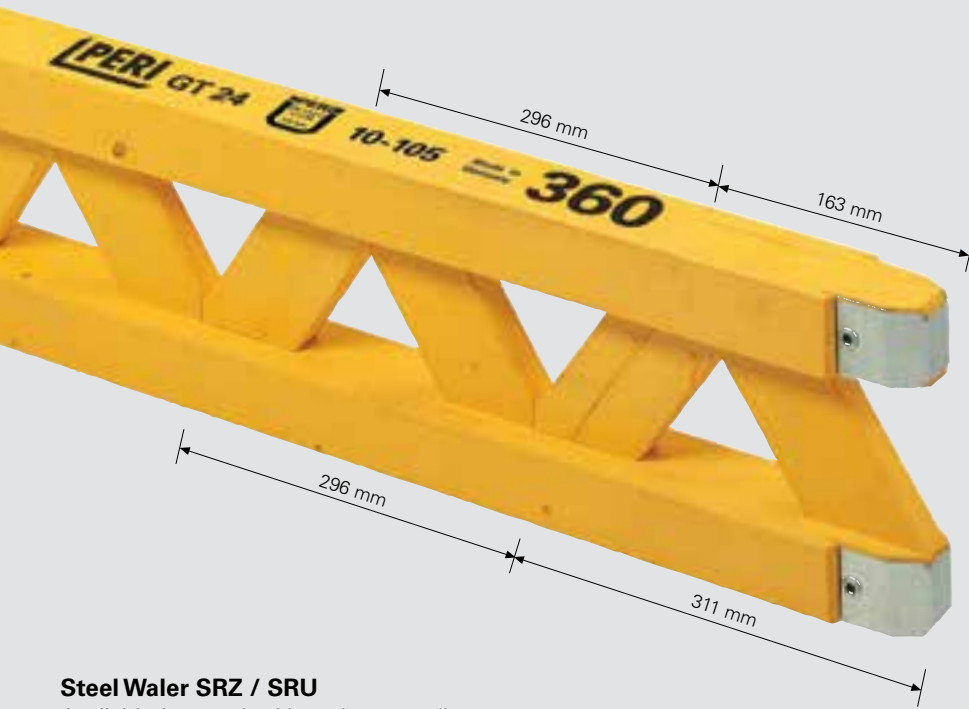

Cross-section

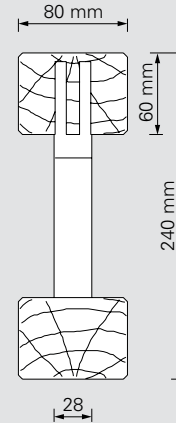

### Steel Waler SRZ / SRU

Available in standard lengths as well as any special sizes and forms. Profile cross-sections of the U 100 to U 140 and others.

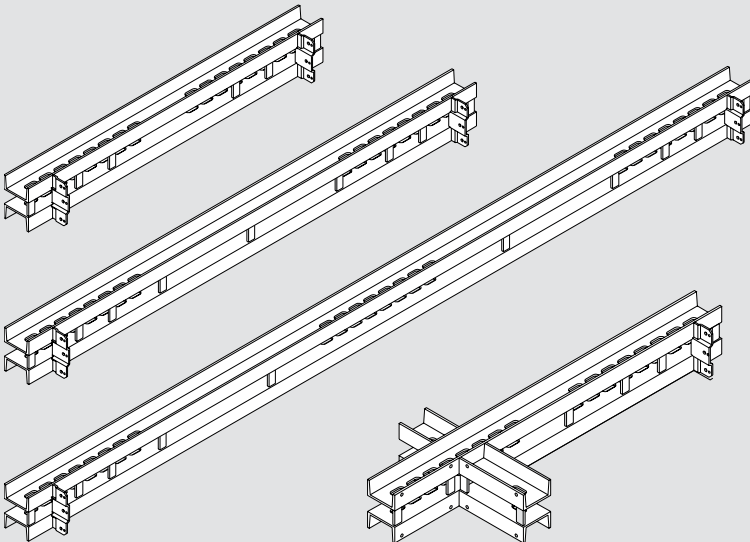

VARIO Steel Waler and Internal Corner Waler IRZ for corner panels.

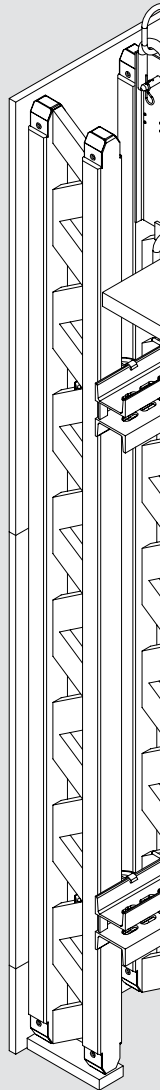
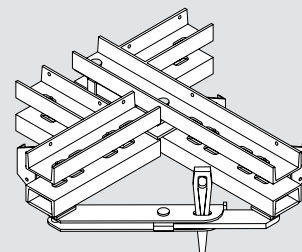

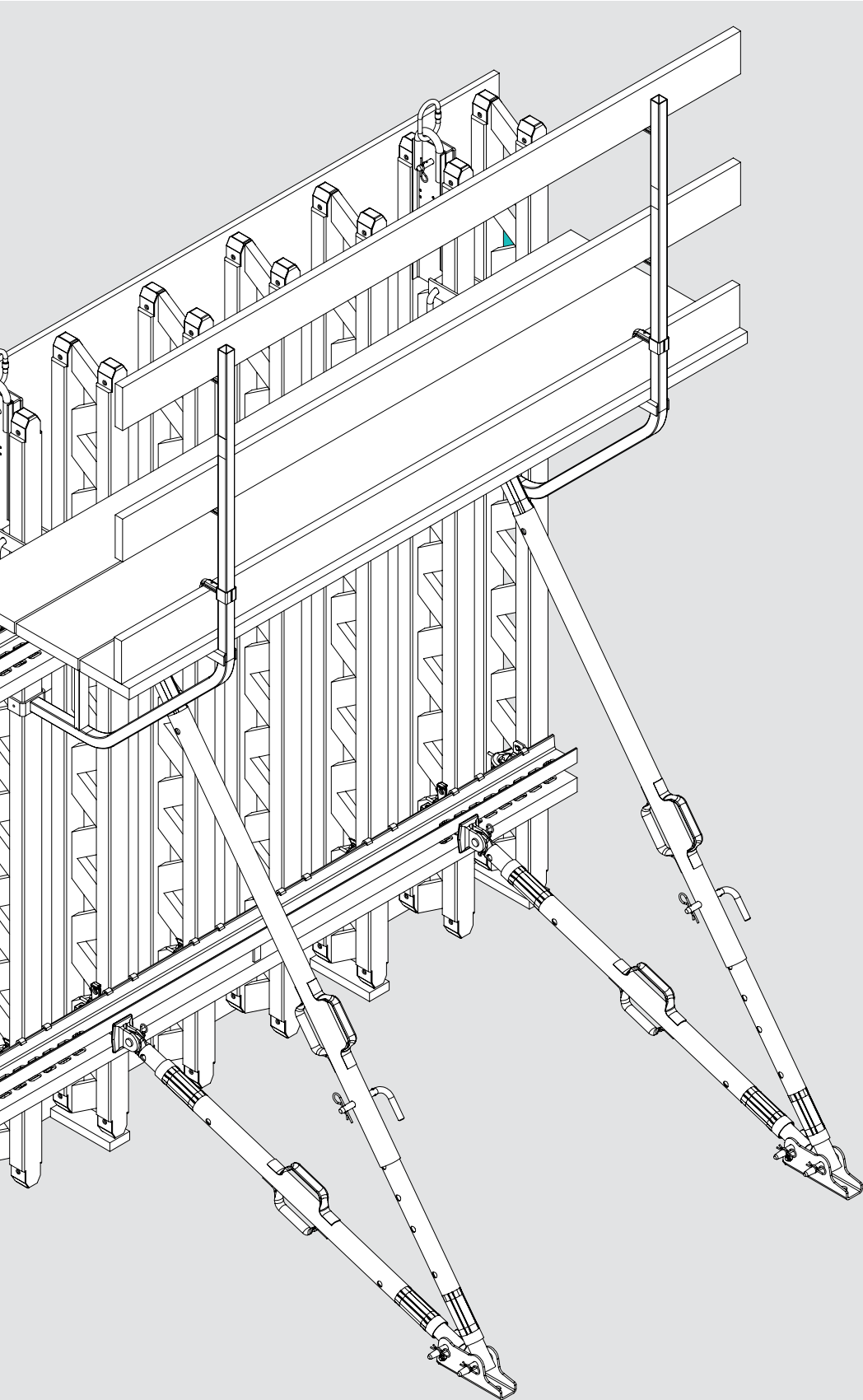

**Formlining**

PERI formlining sheets come in a range of sizes, thicknesses and grades to ensure that the most appropriate formlining is available to meet individual site requirements.

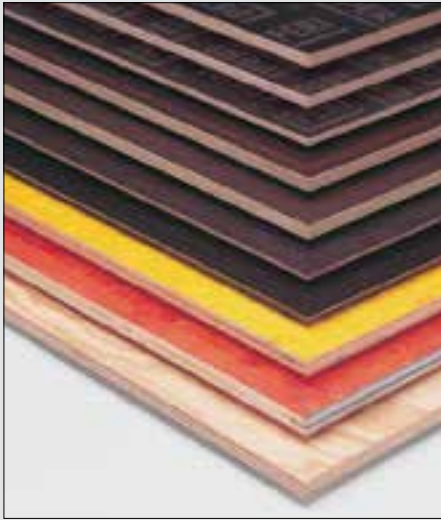

**Connecting components**

**Hook Strap HB 24**  
for connecting the GT 24 to SRZ and SRU walers on the girder nodes.

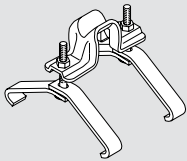

**Hook Strap Uni HBU**  
for connecting the GT 24 to SRZ and SRU walers outside of the girder nodes.

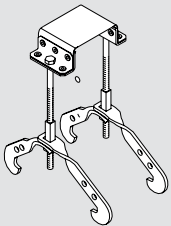

**TSS Torx Screw**  
for assembling the formlining.

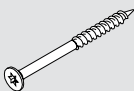

# Standard Applications

## VARIO GT 24 standard panels

VARIO GT 24 standard elements complete with platforms.

**VARIO standard panels are pre-assembled rentable formwork panels which are fitted with 21 mm formlining.**

The ready-to-use wall formwork is assembled using tried and tested VARIO system components. The panels are supplied complete with lifting eyes and rubbing board.

**Permissible fresh concrete pressure:**  
 60 kN/m<sup>2</sup> with tie spacings 55/140/55  
 or 50 kN/m<sup>2</sup> with tie spacings  
 62.5/125/62.5 according to DIN 18202,  
 Table 3, Line 7.

Integrated crane lifting unit as well as top cover board for protecting against concrete splashes.



### Height increments

VARIO standard panels are available in 60 cm height increments. These panels are simply extended for greater heights.

Base panel for extension without top cover.

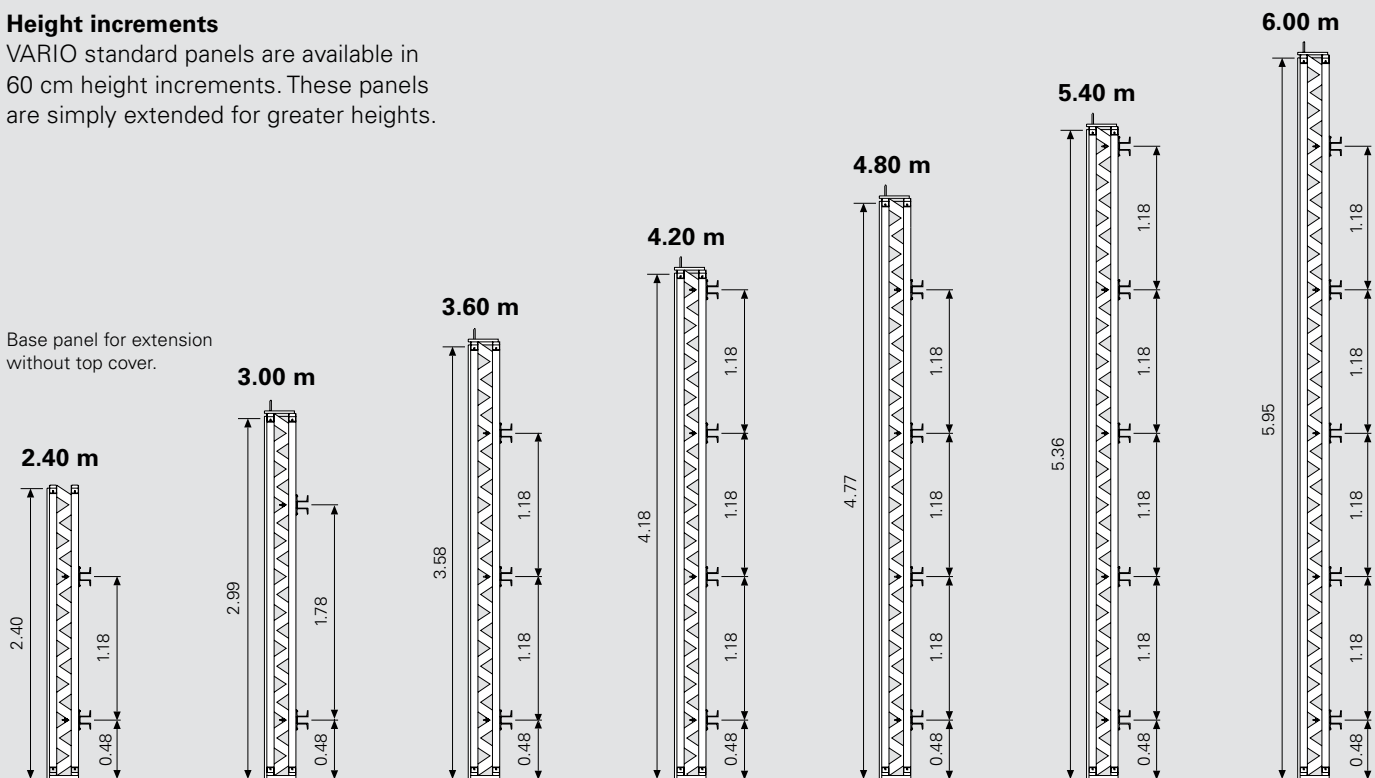

VARIO standard panels for 9 m high tunnel walls.



**Width increments**

VARIO standard panels are available in 4 widths:

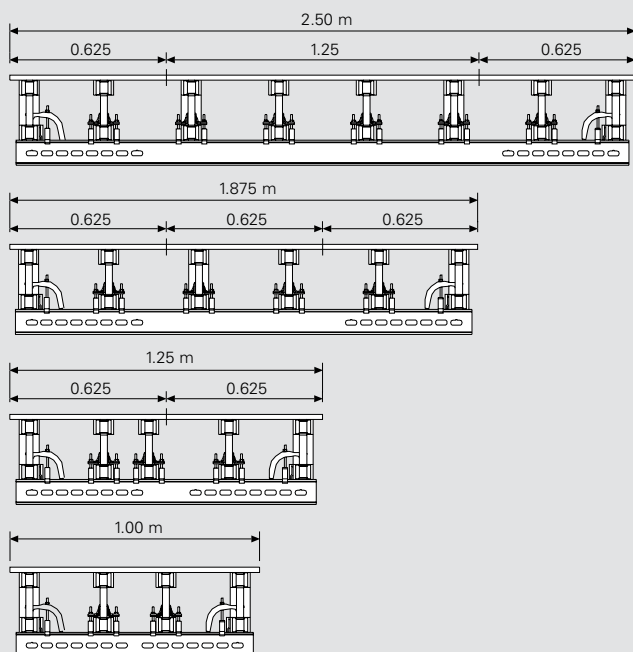

**VARIO standard internal corners**

The consistent leg length of 75 cm allows this design to be used as a left-hand or right-hand corner.

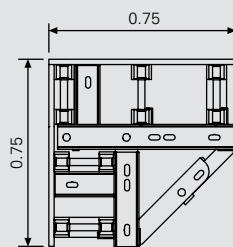

The VARIO standard internal corner is available in 5 heights: 2.40, 3.00, 3.60, 4.80 and 6.00 m.



# Standard Applications

## Continuously adjustable panel connections

The rows of slots in the PERI steel walers and couplings allow continuous tightening of panel joints of even roughly erected panels.

### VARIO Coupling VKZ

With the VARIO coupling, the panels are simultaneously aligned.

The multi-functional VARIO coupling with the wedge:

- continuously tightens until joint is grout-tight
- aligns panels
- supports plywood fillers
- extends the width of panels
- fixes stopend formwork
- stabilises internal corners
- is continuously adjustable on both sides

### Important:

PERI steel walers and couplings have notches in the elongated holes. These must always point towards the concrete side. As a result, the tolerances are equal to zero and the panel joints are optimally aligned.

### Standard joint

The continuous adjustment possibility ensures extremely tight panel joints.

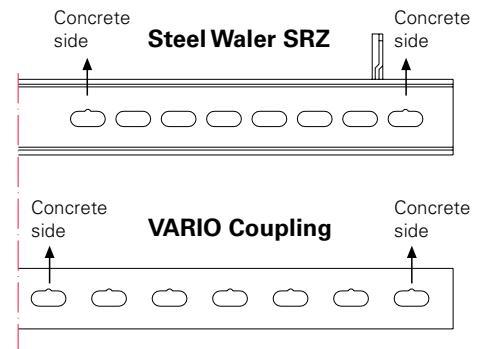

### Filler joint

Any gap up to 1.25 m wide can be filled.



### Internal corner

The same VARIO coupling as for the straight joint.



### Oblique joint

Any angle can be shuttered with the articulated coupling.



### Practical tip

Whether a wedge is locking or pulling is evident from its inclination:

Wedge tip points to the element joint

= wedge pulls

Wedge tip points away from the element joint

= wedge pushes

wedge locking

wedge pulling

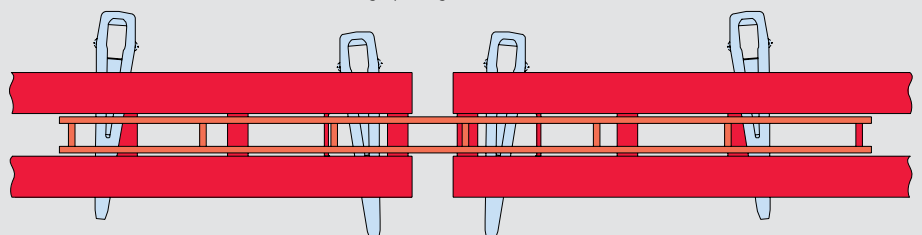

**Neat and precise panel joints are always specifically required where special architectural requirements are placed on the concrete surface.**

**VARIO Coupling Concrete Finish VKS**

With the VARIO Coupling VKS and the Alignment Clamp VRS, it is easy and quick to carry out.

The Coupling VKS allows offsets up to 5 mm to be compensated. At the same time, the Coupling VKS can be used as a "standard panel connection".



**Handling**

- Centrally position the Coupling VKS on the element joint in the steel water.
- The smaller side of the trapezoidal-shaped cut-outs point to the plywood. (Fig. 1)

- Position the Wedges KZ in the same way as with coupling VKZ.
- With element offsets, mount Alignment Clamp VRS on Panel ① which is positioned more rear.
- Release pulling wedge on Panel ②.
- Use counter wedge to slightly open the formlining joint on Panel ②. (Fig. 2)

- Loosen pulling and counter wedges on Panel ①.
- Eliminate panel offset by tensioning the Alignment Clamp VRS.
- Release pulling wedge on Panel ②.
- Tightly close joint on Panel ② with counter wedge.
- Counter with pulling wedge on Panel ②. (Fig. 3)

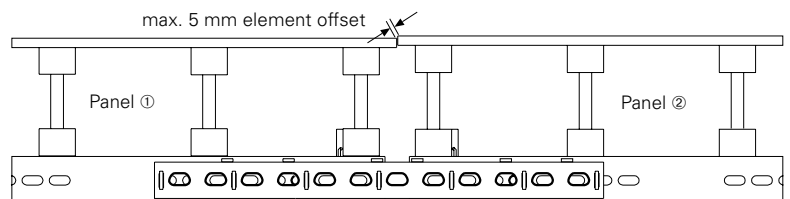

Fig. 1

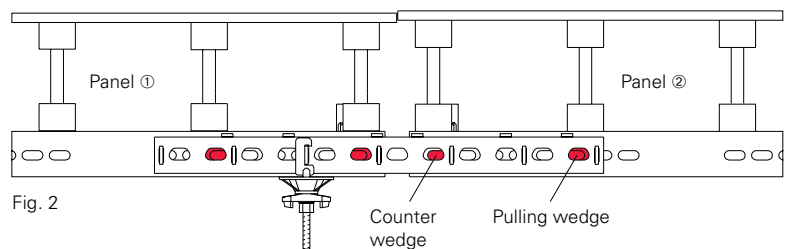

Fig. 2

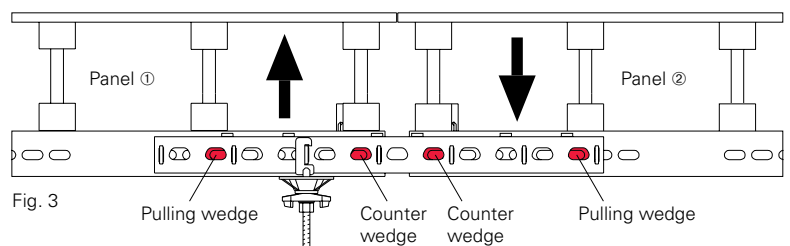

Fig. 3

# Standard Applications

## Fillers, stopend formwork and panel width extensions units

### Infill areas

VARIO GT 24 infill areas are shuttered using the Couplings VKZ 147 and VKZ 211.

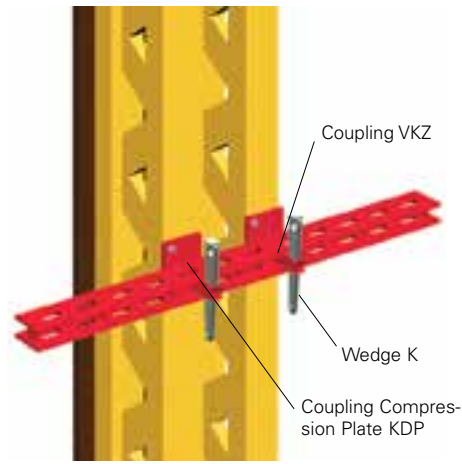

Continuous infill area width with Couplings VKZ.

### Coupling VKZ 147

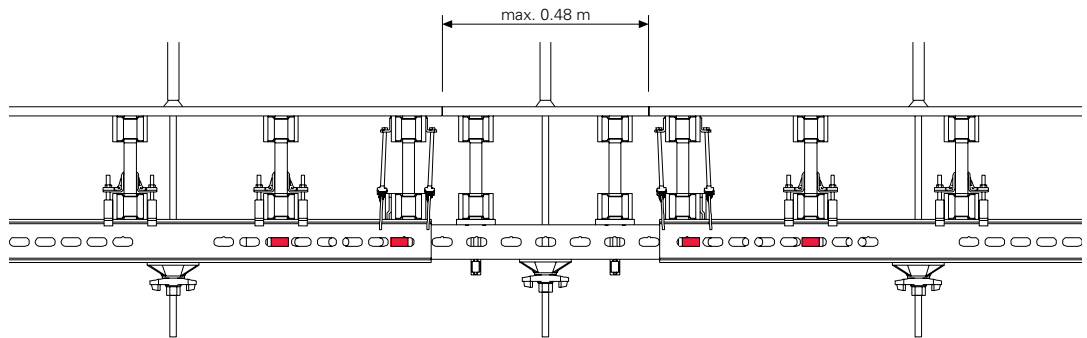

### Coupling VKZ 211

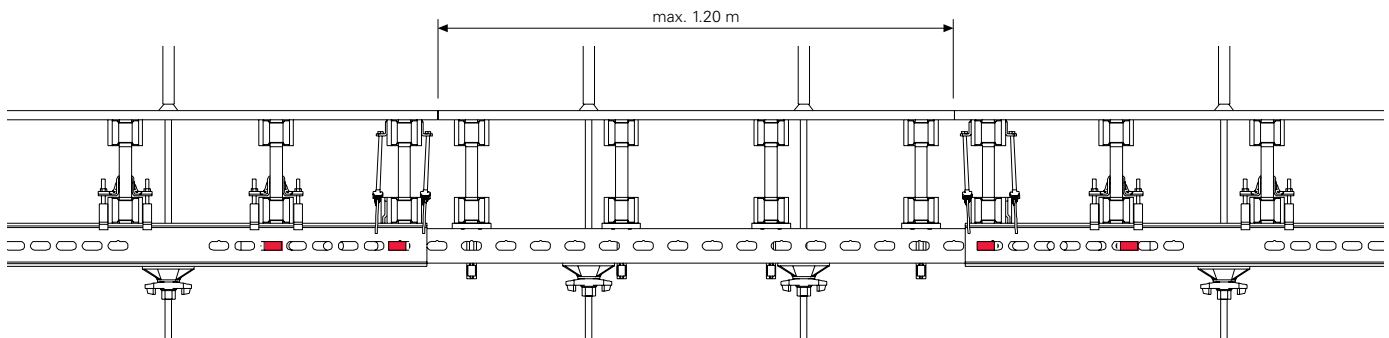

## Stopend Formwork

VARIO offers 2 possibilities for realising stopend formwork: either the Coupling VKZ or Bulkhead Tie is used.

### Coupling VKZ

perm. tension force 50 kN.

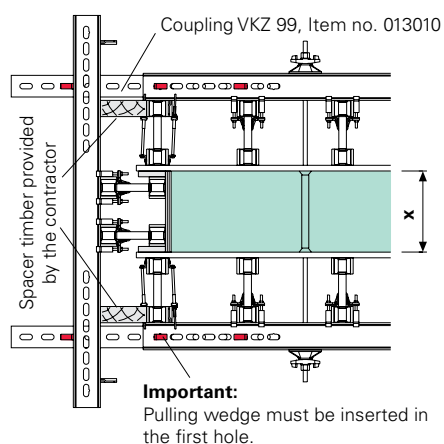

### Bulkhead Tie

perm. tension force 30 kN.

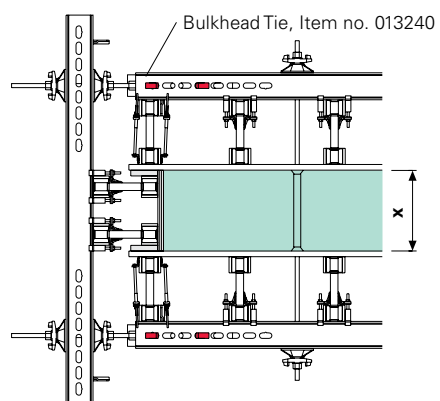

Complete stopend formwork with bulkhead tie.

## Panel width extensions



Panel width extensions are also realised using VARIO with system components.

# Standard Applications

## External corners, internal corners and shafts

Depending on the application, external and internal corners can be formed in various alternative ways.

- With VARIO Corner Panels
- With Cross Walers & Shaft Corners
- With Special Walers

### VARIO Corner Panel

With this solution, especially for thin walls and low utilisation, the fillers consist of standard components.

#### External:

Panel w = 2.50 m  
1 panel with extension.

#### Internal:

Corner Panel w = 1.25 / 0.50 m and  
Panel w = 1.25 m with filler element.



### Internal Corner

VARIO Internal Corner with filler element.



### External Corner

Ensure that it is tightened when the correct angle is achieved. The continuous adjustment possibility facilitates this process.



The waler on the panel width extension unit must project 2 cm to enable firm pre-tensioning of the corner.

### Details of the VARIO Corner

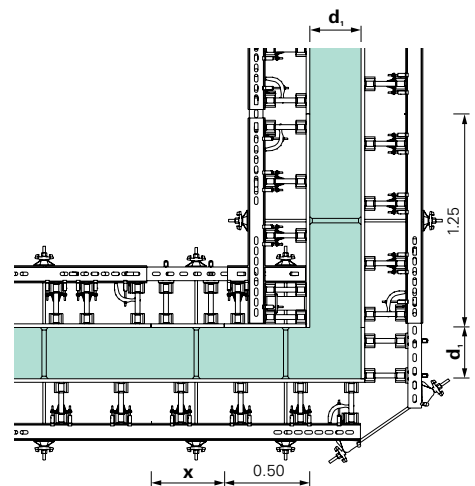

## Shafts

In particular, small shafts can be realised extremely cost-effectively with customised Cross Walers and the quick-release Shaft Corner SSE.

### Practical tip

The shaft corner should be stripped at the very latest one day after concreting.

Details of the Quick Release Corner

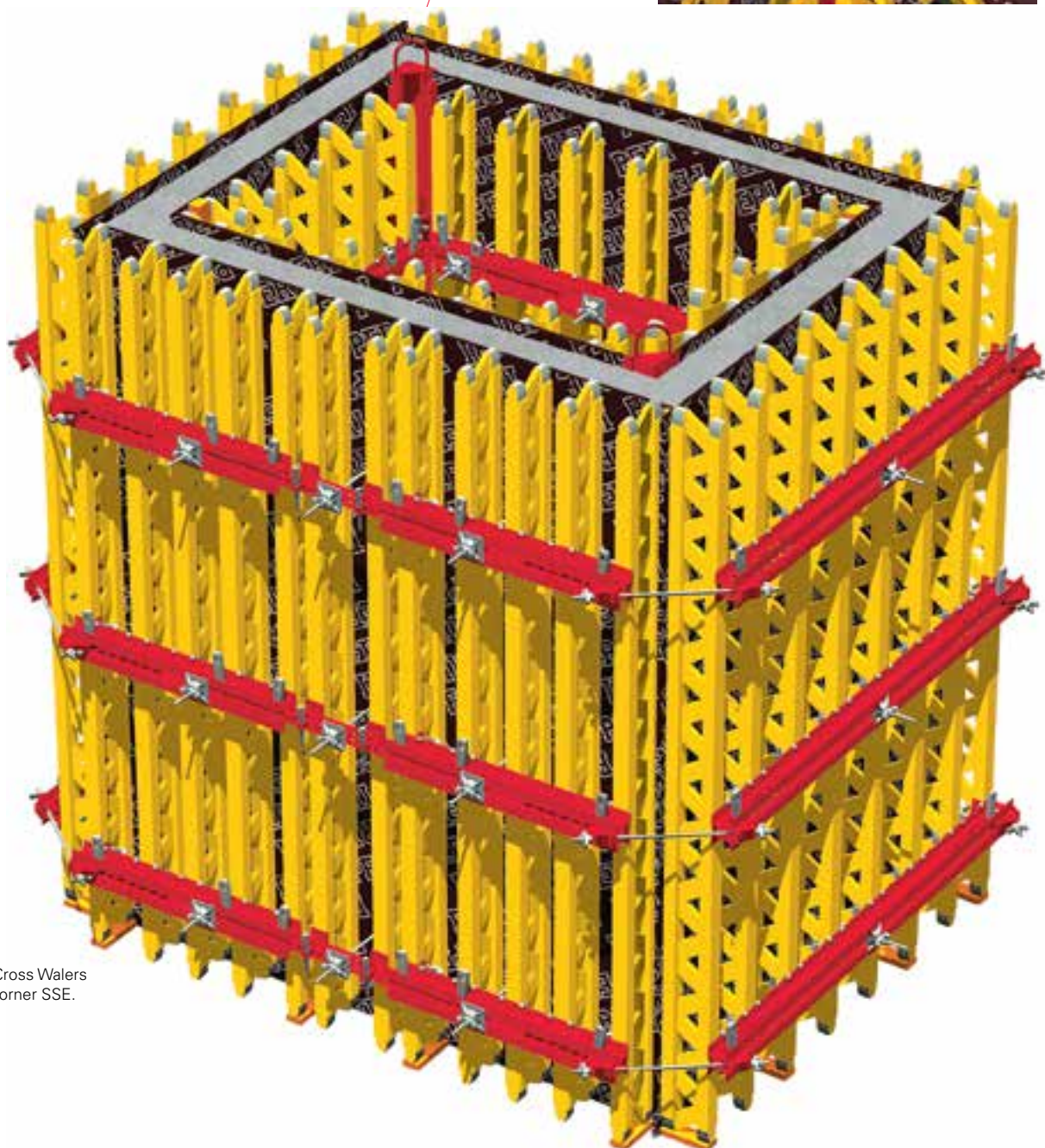
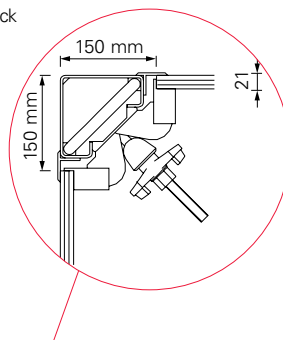

Small lift shaft with Cross Walers and Quick Release Corner SSE.

# Standard Applications

## Push-pull prop connector, crane lifting units

### Push-Pull Prop Connector

Connecting the push-props and kickers to the VARIO panel is carried out using the Girder Headpiece or Wedge Headpiece. Fixing to the slab takes place using Base Plates and PERI Anchor Bolts 14/20 x 130.

**The first panel must always be secured with 2 push-pull props.**

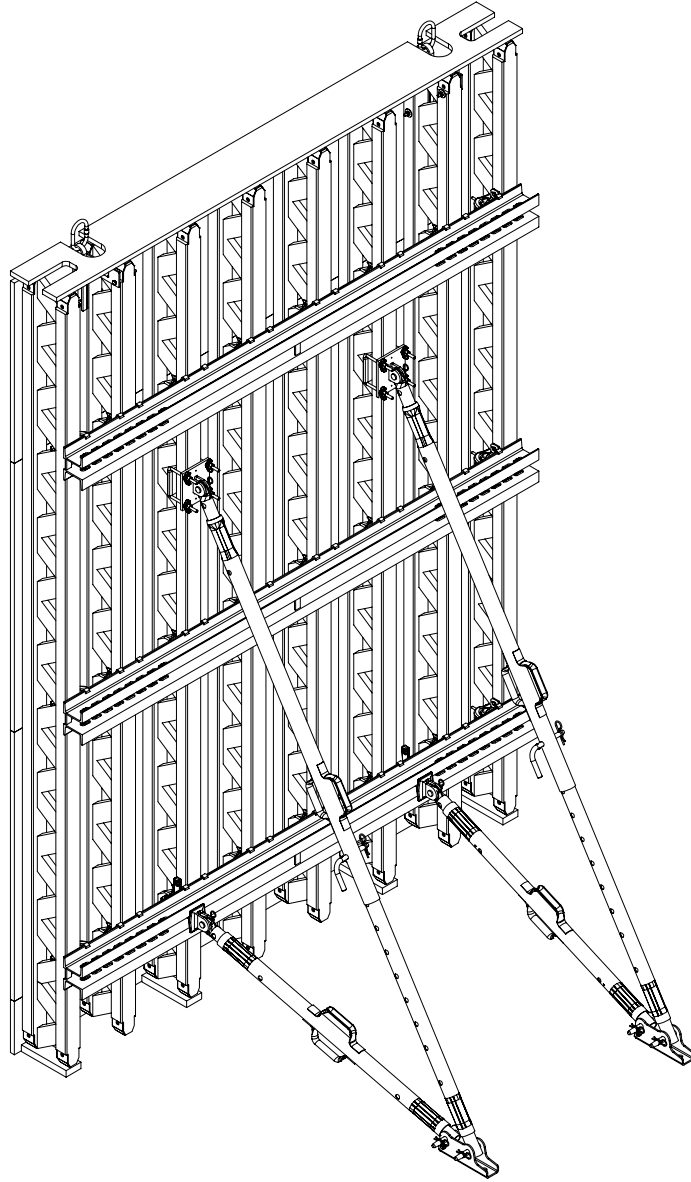

Connecting to the GT 24 girder by means of the Girder Headpiece, Item no. 028050.



Connecting to Steel Waler SRZ with the Wedge Headpiece, Item no. 028060 and Wedge K, Item no. 024250.

## Crane Lifting Unit

**PERI VARIO offers three possibilities for lifting panels with the crane.**

### 1. The Crane Splice 24

as easily assembled and dismantled lifting unit.

### 2. The Crane Lifting Eye 24, right / left

as permanently mounted lifting unit.

### 3. The Crane Lifting Unit 2 t / GT 24

for very heavy formwork units.

#### Important:

In general, two crane lifting units are used per moving unit. The Instructions for Use contain important information and must be followed at all times.

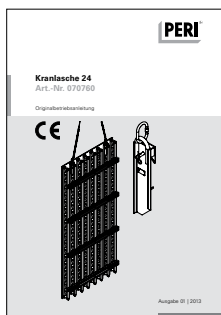
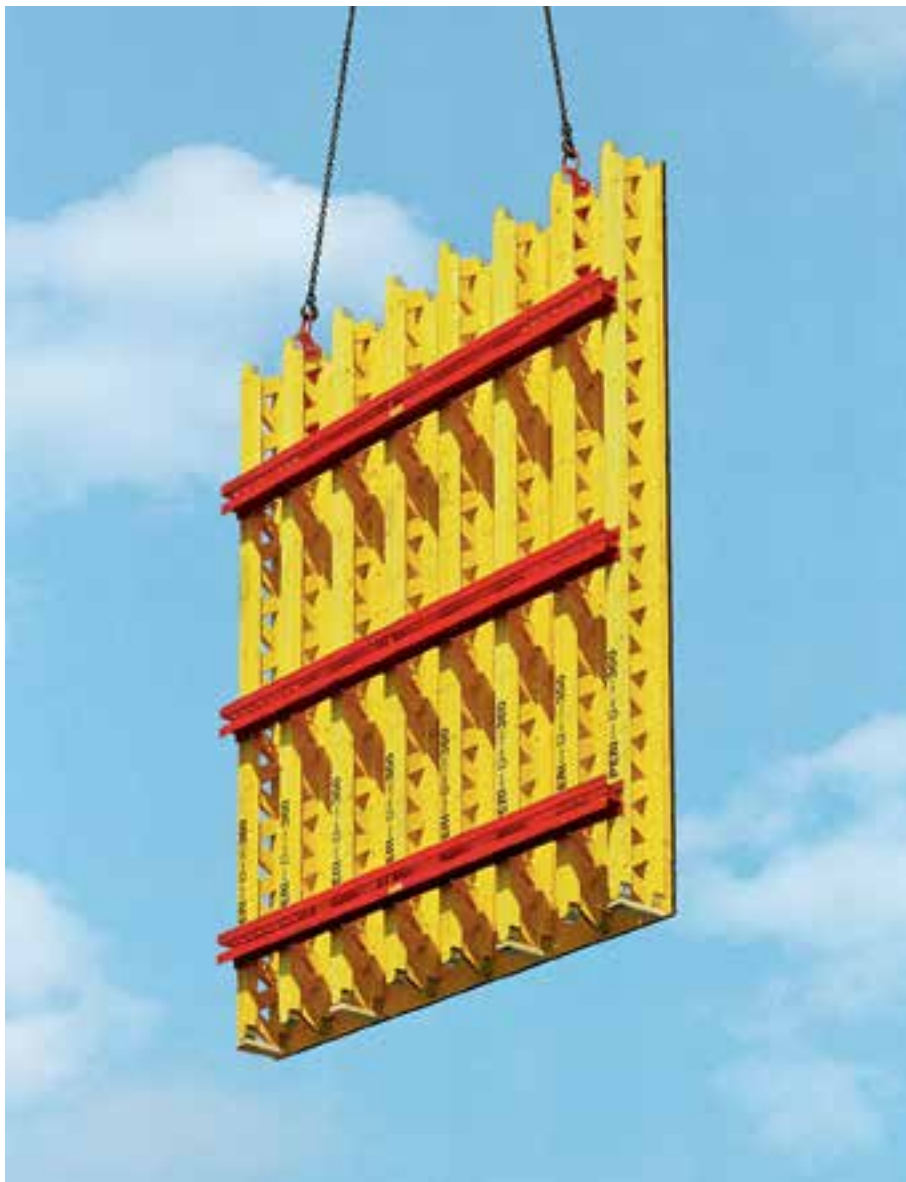

Instructions for Use for the Crane Splice 24.

Customized, ready-to-use VARIO GT 24 element.



Instructions for Use for the Crane Lifting Unit 2t/GT 24.



#### Crane Splice 24

Permissible load-bearing capacity 700 kg with a crane sling angle of max. 15°.



#### Crane Lifting Eye 24, right/left

Permissible load-bearing capacity 700 kg with a crane sling angle of max. 15°.

# Standard Applications

## Working and Concreting Scaffold

### Scaffold Bracket GB 80

The Scaffold Bracket GB 80 is used for the assembly of an 80 cm wide working scaffold. Scaffold components supplied by the contractor must comply with local valid safety regulations (for Germany DIN 4420). Timber components must conform at least to S10 or MS10 classification according to DIN 4074 as well as being clearly marked (BGR 169). Cross-section of guardrail boards: 3 cm x 15 cm. Secure planking and guardrails with nails or screws.

A correctly assembled concreting platform complete with PERI End Guardrail Frame 55, Item no. 065066.



PERI Scaffold Bracket GB 80,  
perm. working load 1.5 kN/m<sup>2</sup>,  
max. width of influence 1.25 m.

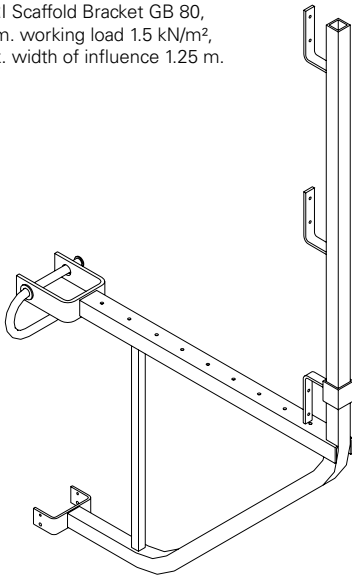

Several working platform levels are required at great heights.



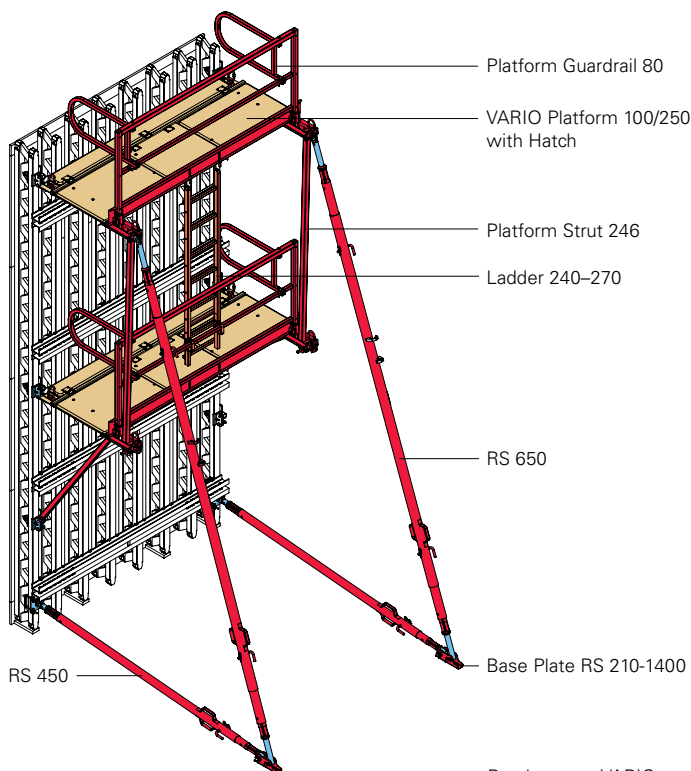

Ready-to-use VARIO standard panel  
h = 5.40 m with 2 concreting plat-  
forms, ladder and push-pull props.

## VARIO Platform System

**Pre-assembled concreting/working platforms in different widths. Complete with guardrails, end hand-rail frame, push-pull prop connections and crane eye. With or without access hatch.**

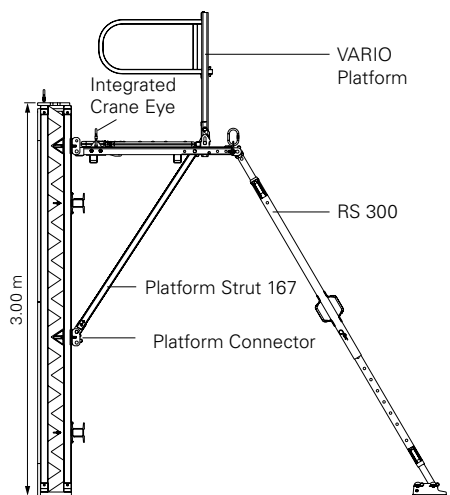

# Standard Applications

## Panel extensions

### Heights up to 8.00 m

The standard method of extension is to use the VARIO Extension Splice 24.

The flexurally stiff connection also automatically aligns the panels. The splice consists of only two components and is connected in no time with two quick action wingnuts.

#### Static values for the Extension Splice 24

$M_{perm.} = 1.73 \text{ kNm}$   
 $Q_{perm.} = 0 \text{ kN}$   
 or  
 $M_{perm.} = 0 \text{ kNm}$   
 $Q_{perm.} = 5 \text{ kN}$

60 cm high timber extension simply realised with the Extension Splice 24.



Assembly of the Extension Splice 24 takes place through the lattice work of the GT 24 without having to drill the girders.

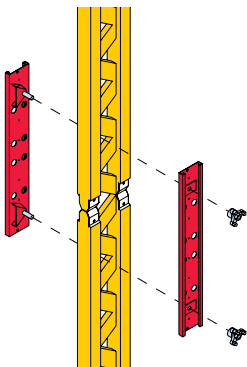

#### Extensions up to 5.00 m

4 x Extension Splices 24 for a 2.50 m element width.

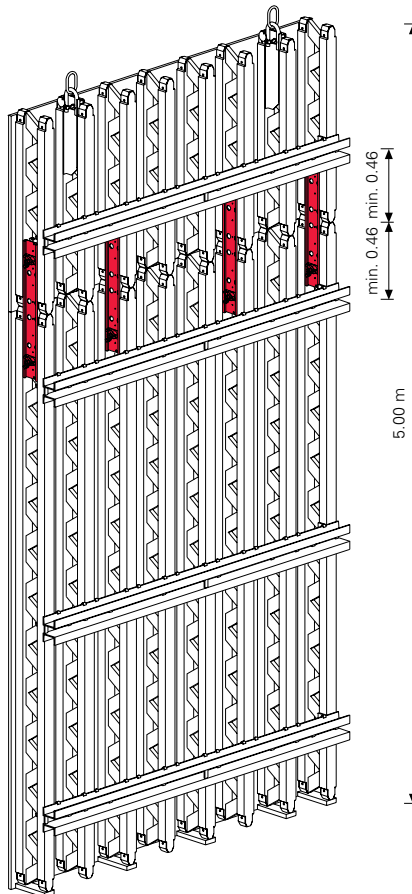

#### Extensions up to 8.00 m

8 x Extension Splices 24 for a 2.50 m element width.

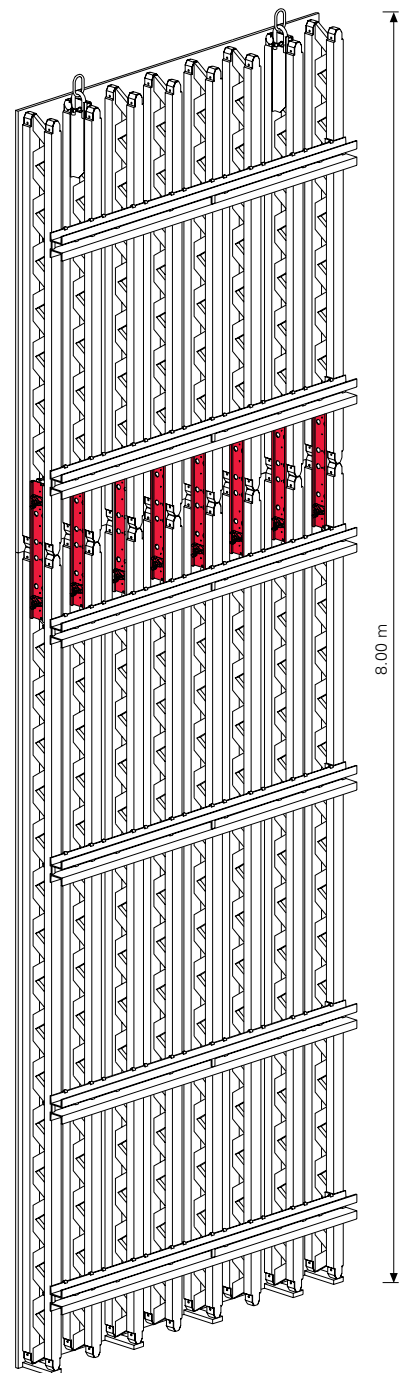

11.00 m high bridge abutment with butted girders and additional overlapping girders for stiffening.



**Heights up to 9.80 m**  
with overlapping girders.

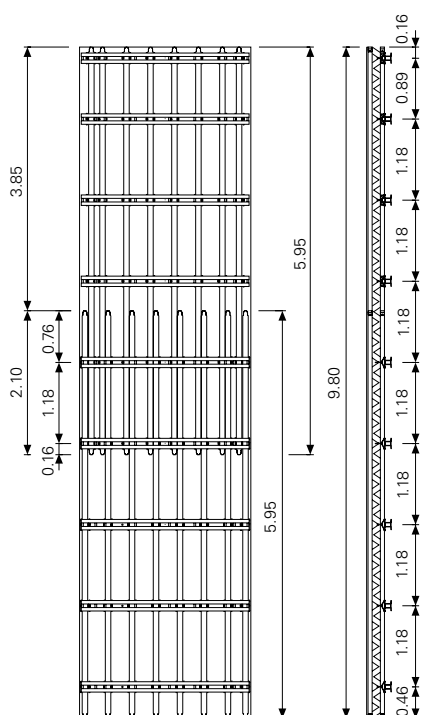

**Heights up to 11.90 m**  
with additional girders.

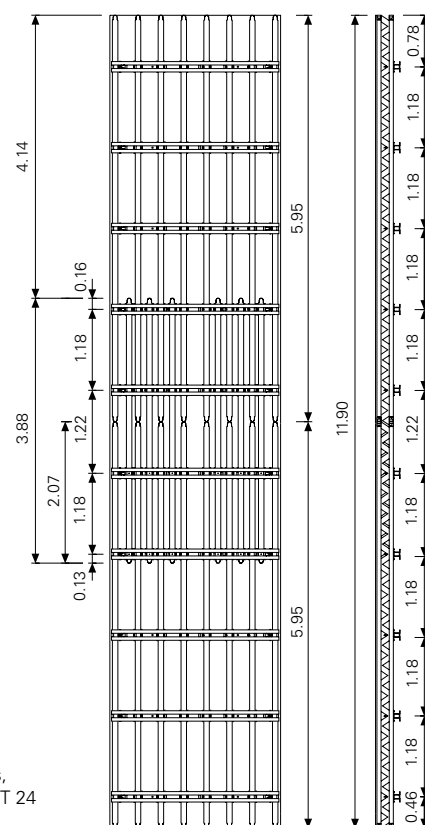

For more information on extensions, see PERI Design Tables or VARIO GT 24 assembly instructions.

# Special Applications

## Architectural concrete | Perfect concrete surfaces with VARIO

Achieving a first-class architectural concrete finish is primarily a question of selecting the most suitable formwork and formlining. Other factors such as the accuracy of the formwork assembly, shuttering work, concrete release agent, concrete and its placing all significantly influence the result. Through the free choice of girder lengths and spacings, tie positions and formlining, the VARIO GT 24 girder wall formwork offers the highest possible degree of flexibility for the realisation of architectural concrete structures.



Attractive looking concrete finish with rough vertical board finish.

43.50 m high tower with architectural concrete with a board finish for an industrial plant.



Exemplary fairfaced concrete with rough horizontal board finish.



Church steeple in Feldmoching near Munich. VARIO GT 24 on KGF 240 climbing formwork.

Consecration Hall, Neuburg, Germany. VARIO with an orderly tie pattern. Formlining screwed on from the rear.



Perfect architectural concrete finish with horizontal and vertical pinnular pattern.

# Special Applications

## Architectural concrete | Perfect concrete surfaces with VARIO

Due to the freely configurable waler and tie spacings, numerous possibilities for realising neat joint and tie arrangements can be executed.



An orderly pattern of ties spaced at 0.75 x 1.18 m and smooth, architectural concrete are the result (Secondary School in Kletov).

### 2.50 x 3.60 m panel

with tie spacings of 1.25 x 1.18 m.  
2 ties horizontally, 3 ties vertically.

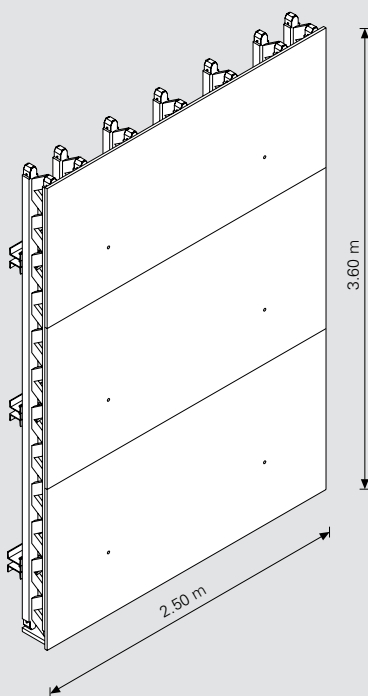

### 2.50 x 3.60 m panel

with tie spacings of 0.88 x 1.78 m.  
3 ties horizontally, 2 ties vertically.

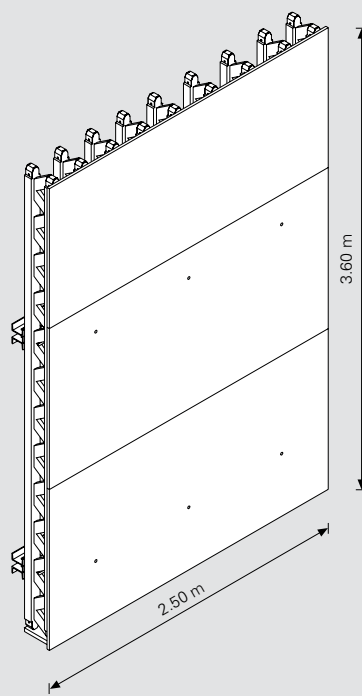

### 3.00 x 3.90 m panel

Architectural concrete with an orderly pattern of joints and tie spacings of 0.75 x 1.18 m. 4 ties horizontally, 3 ties vertically.

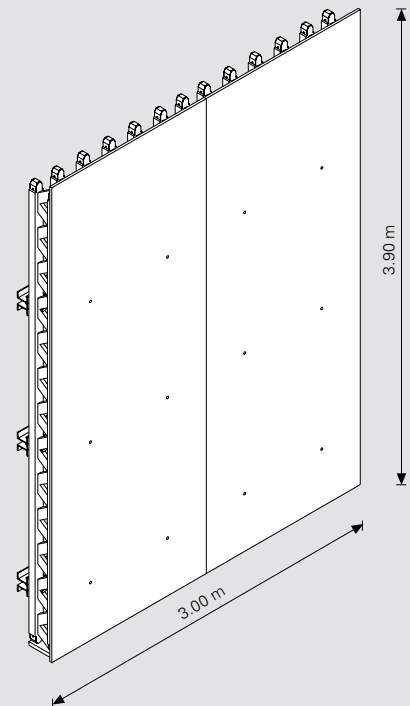

The rough surface finish ensures that the massive tunnel portals blend into the volcanic rock landscape. The unusual washboard structure was created by using extra battens on the formlining.

Portal of a tunnel structure on Hawaii, shuttered with VARIO GT 24 on KGF 240 climbing scaffold.



Forming boards provided by the contractor

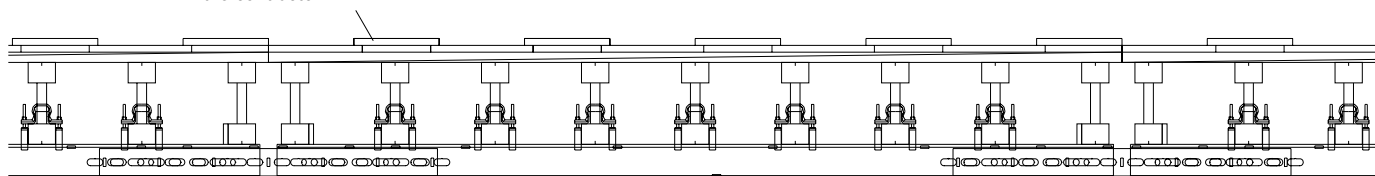

**High-quality architectural concrete with vertical board finish.**

The panels were pre-assembled at PERI's Weissenhorn factory.



The BAB 4 motorway bridge over the Triebischbach valley was constructed with 49 m high circular piers featuring trumpet-shaped pier heads.

# Special Applications

## Bridge construction | VARIO on climbing scaffold and working platforms

Further information:  
Climbing Scaffold CB  
product brochure.



### Type-tested safety with KGF 240, KG 180 and CB 240, CB 160 systems.

The KGF 240 and CB 240 carriages allow the formwork to be moved 0.75 m on the platform without a crane. The formwork is moved together with the scaffold vertically in one crane lift. This saves time.

The KGF 240 and CB 240 provide a high level of safety due to the obstruction-free surface of the platform. The brackets are positioned below the platform which means there are no tripping hazards.

The platform lining can be pre-assembled and can be used immediately when moving from one site to the next. This results in considerable assembly time savings.

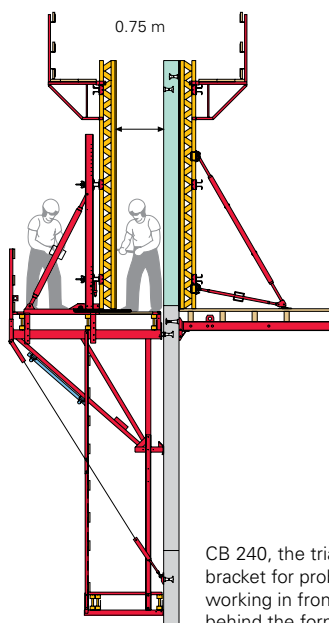

CB 240, the triangular bracket for problem-free working in front of and behind the formwork.



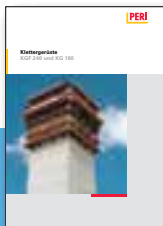

Further information:  
Climbing Scaffold KG  
product brochure.

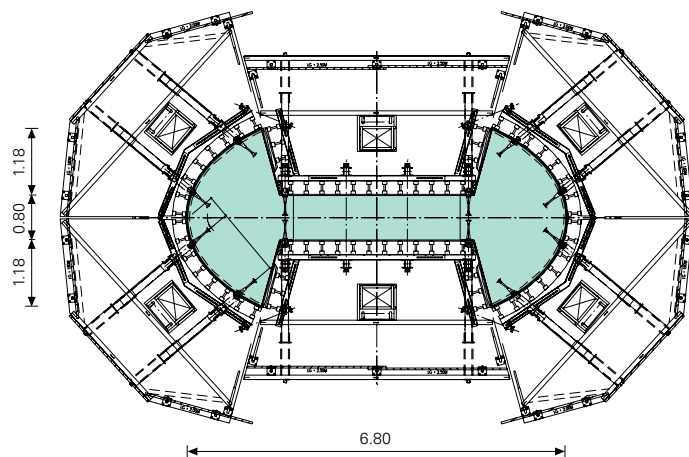

Motorway viaduct in France.  
Sophisticated pier geometry with  
an extraordinary concrete finish.  
Formed with VARIO GT 24 and  
SKS climbing brackets.

**On ASG 160**

**On Folding Platform FB 180**

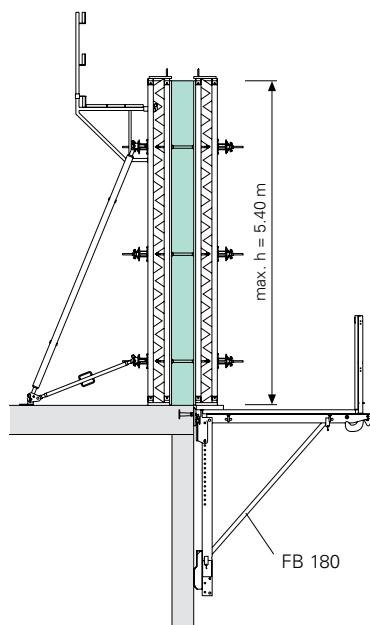
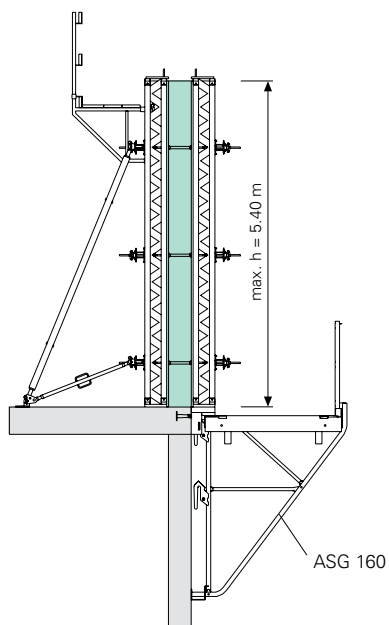

Further information:  
Folding Platform FB 180  
product brochure.

# Special Applications

## Bridge construction | Abutments and piers



Bridge over the Danube,  
BAB 8 motorway near Leipheim.

**Section A-A**

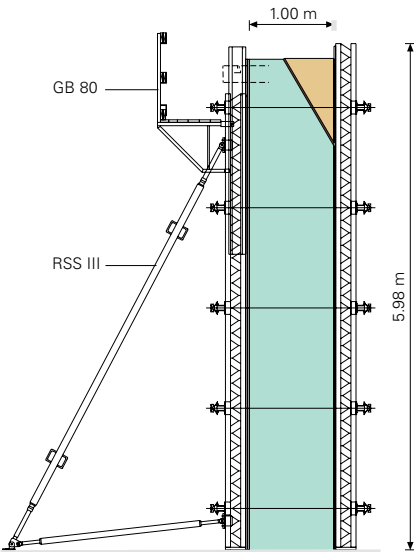

**Ground plan**

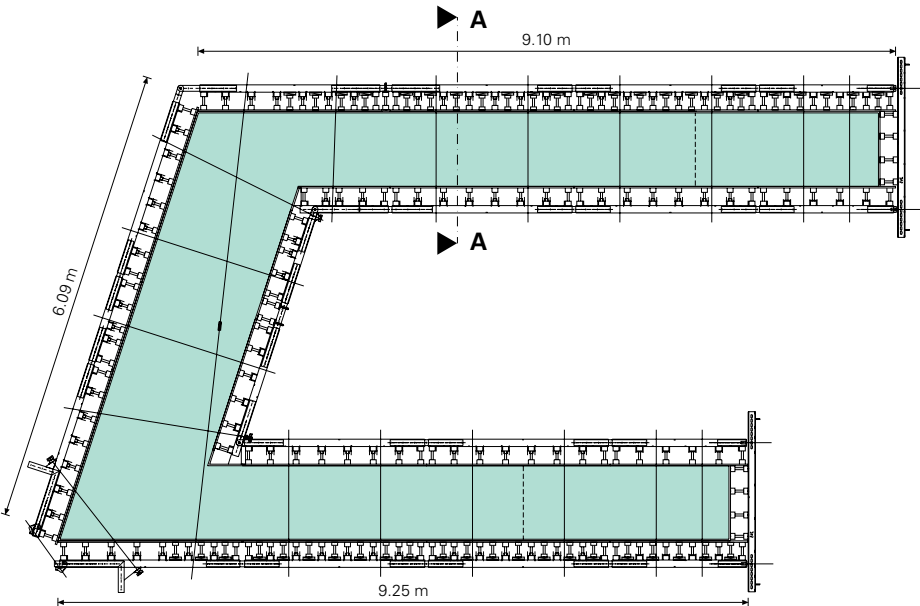

Bridge over the Danube,  
BAB 8 motorway near  
Leipheim.



Abutment and bridge pier with VARIO GT 24. Crossing structure for the suburban railway line to the new Munich Airport.



Sides of hollow piers on the banks of the river, climbed with VARIO GT 24 on PERI KG 240 climbing scaffold. Adapting to the arch-shaped ends was achieved with VARIO standard components and forming boards.

Example of a bridge pier tapered towards the top.

**View of the longitudinal side**

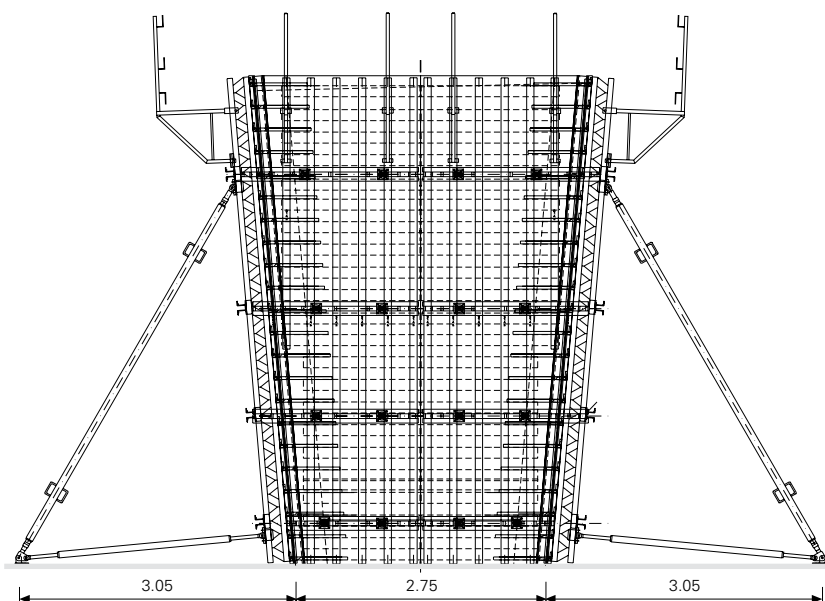

**Section**

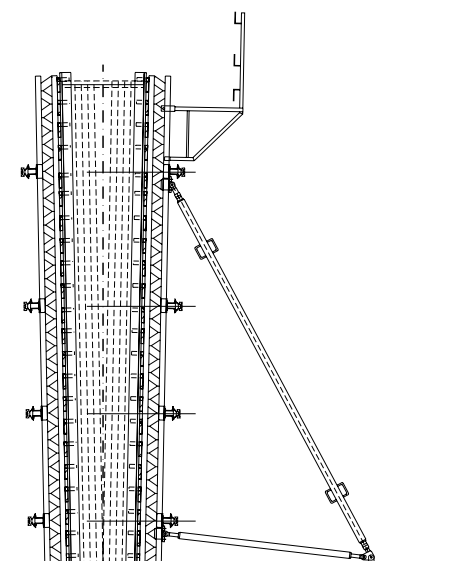

# Special Applications

## Water-retaining structures

### Single-sided forming without formwork ties

When constructing locks, dams, cooling towers and walls requiring single-sided shuttering, VARIO GT 24 is frequently used with KG and CB, or SKS, climbing scaffold systems.



Magdeburg Waterway Intersection.  
The intersection for three transport routes: rail – road – waterway. As part of this major transportation project, a number of key structures had to be realised. The photo shows the Rothensee lock facility. It was formed with VARIO GT 24 on KG climbing scaffold and single-sided SKS climbing scaffold.

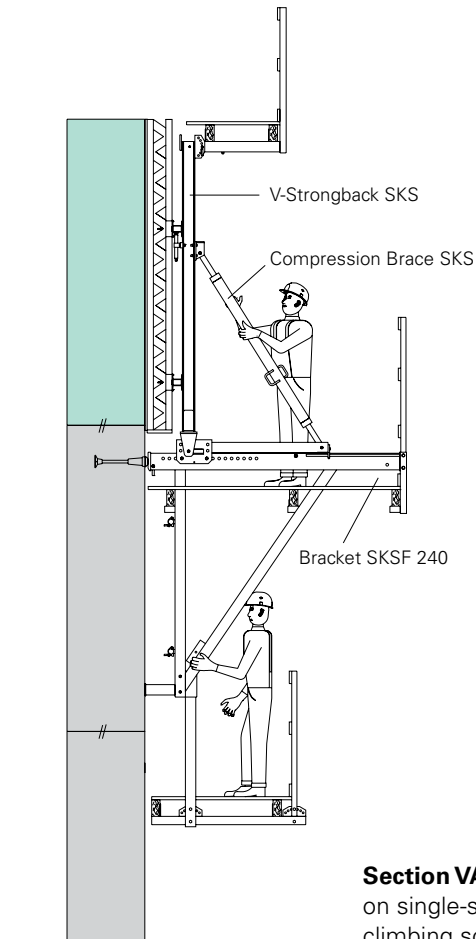

**Section VARIO GT 24**  
on single-sided SKSF 240  
climbing scaffold.

## VARIO GT 24 – tied formwork

**Section VARIO GT 24,**  
tied girder wall formwork on KGF 240 climbing scaffold.

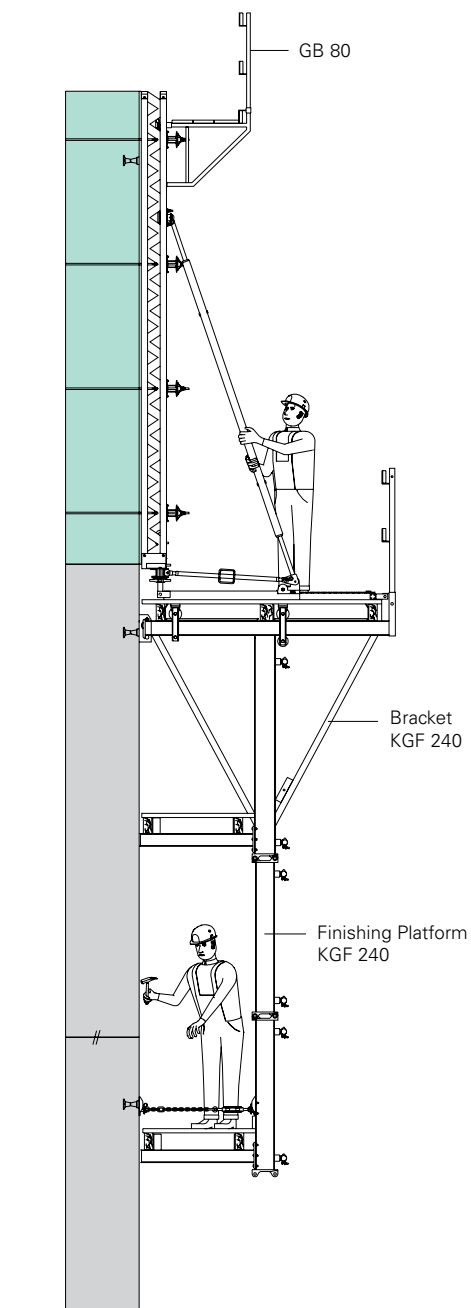

Front of the weir pier. VARIO in combination with GRV circular formwork system on KGF 240 climbing scaffold.



Power station on the River Isar near the town of Plattling-Pielwachs. Pier formwork with VARIO GT 24 in combination with GRV circular formwork. The concrete surface was realised in the form of architectural concrete with a vertical board finish. PERI VARIO GT 24's versatility and easy adaptability makes it a particularly cost-effective shuttering system in this area.

Rear side of the weir pier. The VARIO GT 24 could be easily adapted to suit the inclined rear wall requirements.

# Special Applications

## Water-retaining structures | Circular structures with VARIO

### VARIO GT 24 – for shuttering circular structures

The VARIO articulated couplings connect the straight steel walers in a polygonal arrangement. It can be moved continuously to the right or to the left via the wedges. This results in a flush and neat panel joint.

**In general, two design versions is standard.**



Silo, h = 72 m, Ø = 20 m for power station in Oppeln, Poland. Shuttered with circular VARIO girder formwork on KGF climbing scaffold.



More information on PERI circular formwork: RUNDFLEX and GRV product brochures.

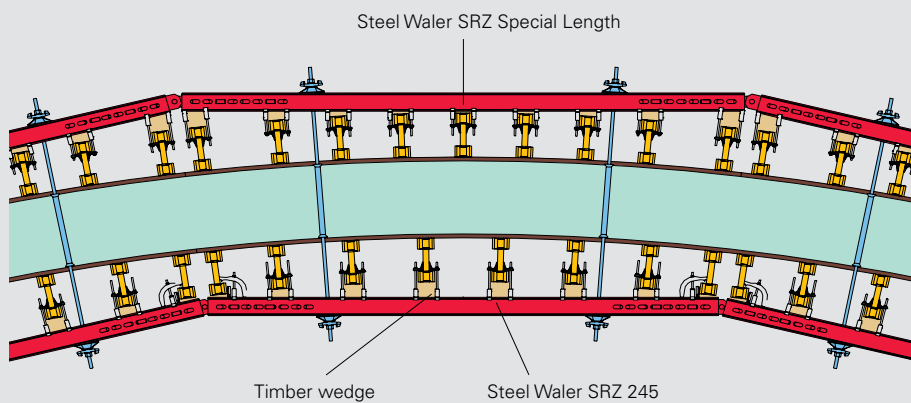

**Version 1**

Spacer timber inserted between GT 24 girders and SRZ steel walers.



The haunched transition to the ground slab was pre-assembled with the VARIO wall formwork panels to form a single unit for lifting.



**Version 2**

Segment profile timbers between the formlining and girders.



7.50 m high circular formwork with segment profile timbers on the GT 24 girders.

# Special Applications

## Single-sided walls | With VARIO and Brace Frame SB

**For concreting against rock faces, existing walls or sheet piling, VARIO GT 24 with SB Brace Frames is used.**

### PERI brace frames

allow single-sided concreting up to a max. height of 8.75 m (see PERI Design Tables).

### PERI Brace Frames SB-A0, A, B, C

are sized for loading on a lorry or in a container.

### PERI brace frames

can be connected to all PERI wall formwork systems with standard system components.



Max. concreting height of 8.75 m, Brace Frame SB-A0, A, B and C with VARIO GT 24 wall formwork.

### The PERI V-Tie Holder

For easy and accurate installation of anchors when using brace frames.

**The V-Tie Holder and the Leading Anchor Coupler allow accurate assembly of the Tension Anchor under 45°.**



Anchor system is easily fixed to the reinforcement with wire and pliers.

The advantages of the anchoring system with the Leading Anchor Coupler and V-Tie Holder are:

- less on-site material requirements
- no need to cut the tie rods to size
- tie rods are recoverable



The Leading Anchor Coupler is removed using the Single-Ended Spanner SW 70.

**The tension forces arising at the brace frame's anchor point determine the choice of anchor system.**

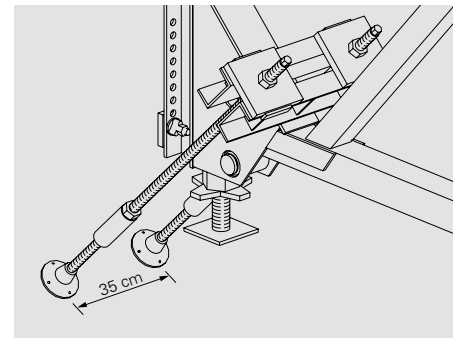



**Example: DW 20 anchor system**  
Perm. tension force according to DIN 18216  $2 \times 150 \text{ kN} = 300 \text{ kN}$ .

**When using PERI brace frames, the following must be taken into consideration:**

1. The structural members (e.g. foundations or ground slabs) must be able to carry the tension and compression forces arising. Check the design of the members and position of the anchors when planning.
2. The "other side" of the single-sided formwork (existing walls, planking, rocks etc.) must obviously be able to withstand the fresh concrete pressure acting upon it.
3. DW tie rods installed for anchoring purposes must not be welded or bent. We recommend the use of PERI V-Tie Holders.

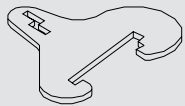
**The following connecting parts are required for connecting VARIO GT 24 to Brace Frames SB-A0, A, B and C:**

<p><b>Waler Connector</b> SB-A, B, C Item no.: 025760</p> 	<p><b>Wedge K, galv.</b> Item no.: 024250</p> 
---	---

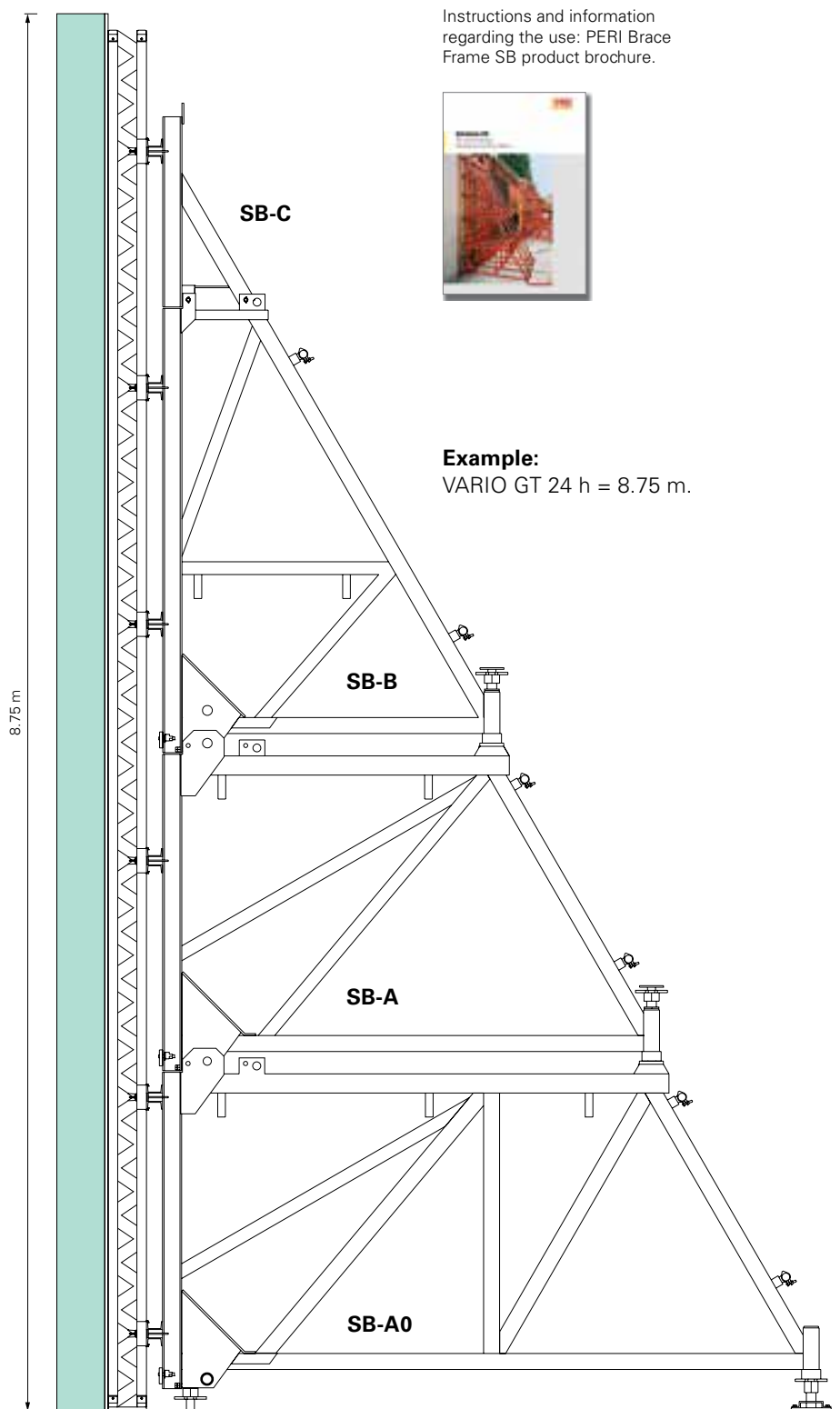

Instructions and information regarding the use: PERI Brace Frame SB product brochure.



**Example:**  
VARIO GT 24 h = 8.75 m.

# VARIO GT 24 Girder Wall Formwork



Item no.	Weight kg		L
		<b>Girders GT 24</b>	
075100	5.300	<b>Girder GT 24, l = 0.90 m</b>	918
075120	7.100	<b>Girder GT 24, l = 1.20 m</b>	1214
075150	8.900	<b>Girder GT 24, l = 1.50 m</b>	1510
075180	10.600	<b>Girder GT 24, l = 1.80 m</b>	1806
075210	12.400	<b>Girder GT 24, l = 2.10 m</b>	2102
075240	14.200	<b>Girder GT 24, l = 2.40 m</b>	2398
075270	15.900	<b>Girder GT 24, l = 2.70 m</b>	2694
075300	17.700	<b>Girder GT 24, l = 3.00 m</b>	2990
075330	19.500	<b>Girder GT 24, l = 3.30 m</b>	3286
075360	21.200	<b>Girder GT 24, l = 3.60 m</b>	3582
075390	23.000	<b>Girder GT 24, l = 3.90 m</b>	3878
075420	24.800	<b>Girder GT 24, l = 4.20 m</b>	4174
075450	26.600	<b>Girder GT 24, l = 4.50 m</b>	4470
075480	28.300	<b>Girder GT 24, l = 4.80 m</b>	4766
075510	30.100	<b>Girder GT 24, l = 5.10 m</b>	5062
075540	31.900	<b>Girder GT 24, l = 5.40 m</b>	5358
075570	33.600	<b>Girder GT 24, l = 5.70 m</b>	5654
075600	35.400	<b>Girder GT 24, l = 6.00 m</b>	5950

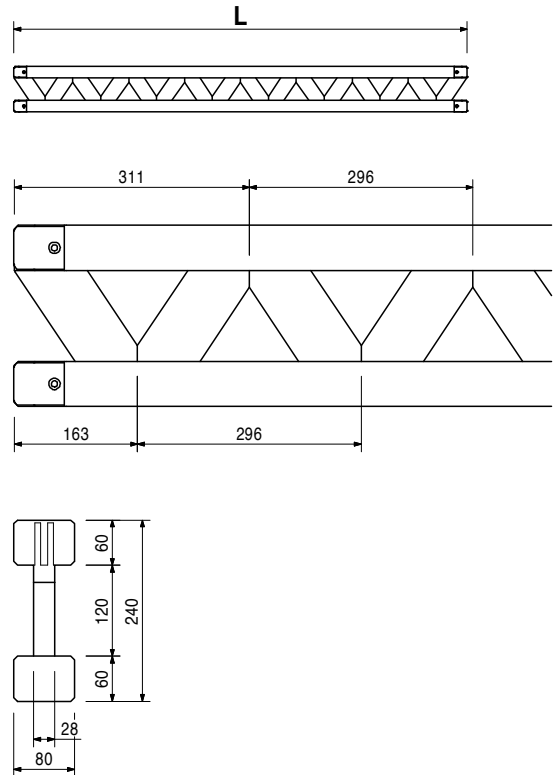
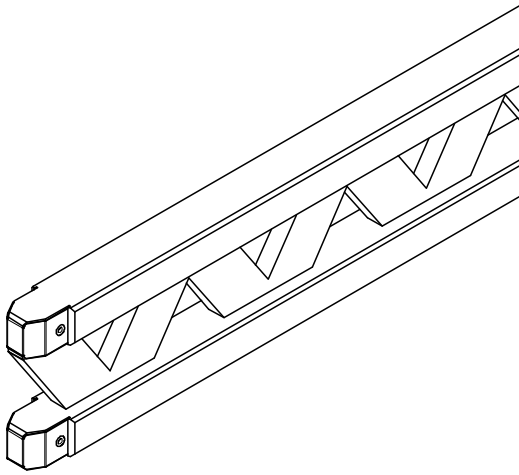

# VARIO GT 24 Girder Wall Formwork



Item no.	Weight kg
101241	320.000
101242	381.000
101243	489.000
101244	597.000
101245	648.000
101246	756.000
101247	805.000

**VARIO Standard Panels S b = 2.50 m**  
**VARIO Standard Panel S 250 x 240**  
**VARIO Standard Panel S 250 x 300**  
**VARIO Standard Panel S 250 x 360**  
**VARIO Standard Panel S 250 x 420**  
**VARIO Standard Panel S 250 x 480**  
**VARIO Standard Panel S 250 x 540**  
**VARIO Standard Panel S 250 x 600**

Pre-assembled panels with 21 mm plywood. With Slip Boards, Cover Board and Crane Eyes 24.

**Note**

Panel h = 2.40 m, without Cover Board and Crane Eyes 24.  
 Permissible load-bearing point capacity 700 kg with crane sling angle  $\leq 15^\circ$ .

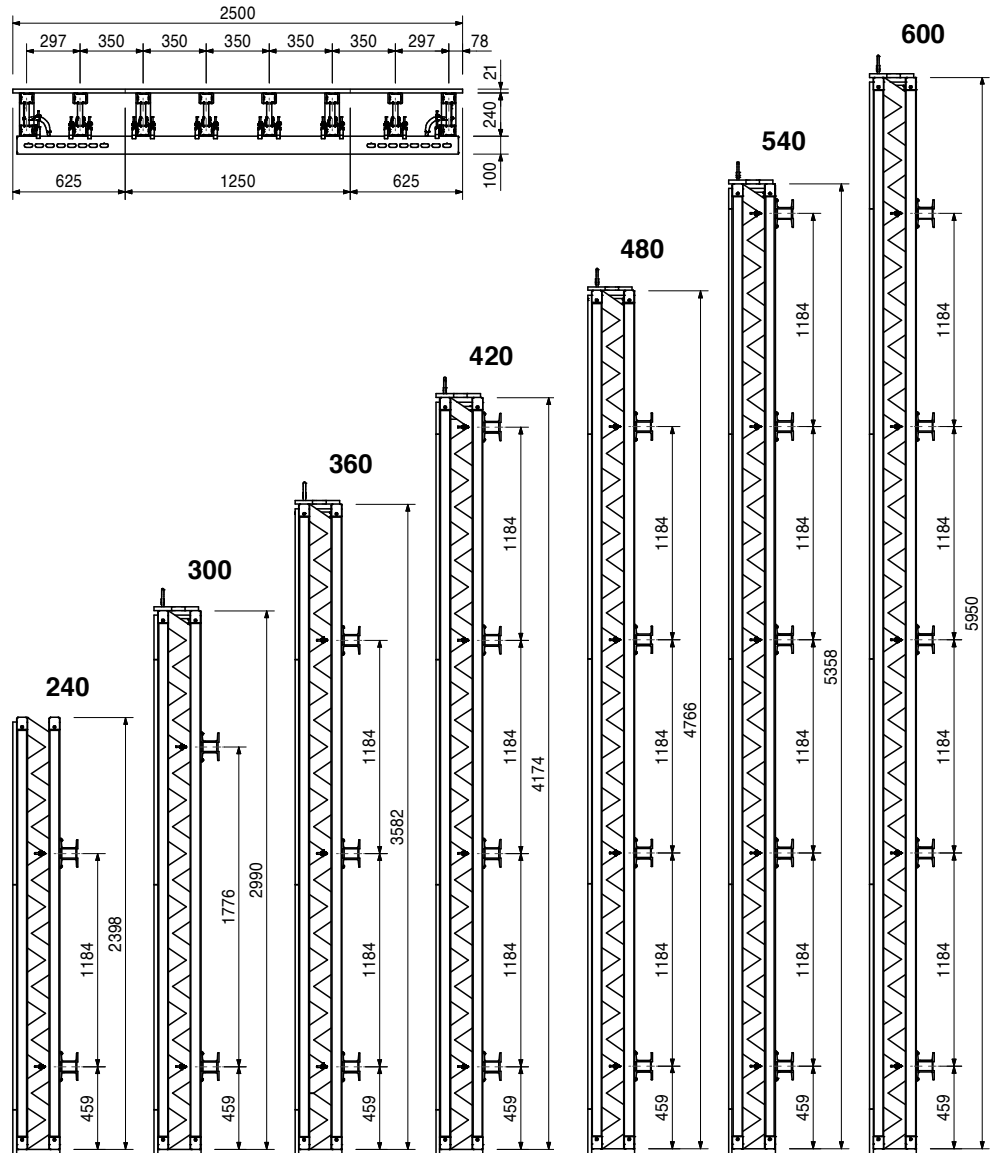

101311	6.170
--------	-------

**Protection Board 250**

As top covering for VARIO GT 24 standard panels.

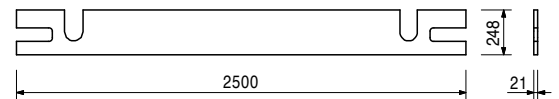
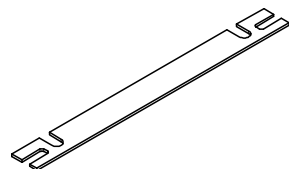

# VARIO GT 24 Girder Wall Formwork



Item no.	Weight kg
101248	237.000
101249	284.000
101250	364.000
101251	444.000
101252	481.000
101253	562.000
101254	598.000

**VARIO Standard Panels S b = 1.875 m**  
**VARIO Standard Panel S 1875 x 240**  
**VARIO Standard Panel S 1875 x 300**  
**VARIO Standard Panel S 1875 x 360**  
**VARIO Standard Panel S 1875 x 420**  
**VARIO Standard Panel S 1875 x 480**  
**VARIO Standard Panel S 1875 x 540**  
**VARIO Standard Panel S 1875 x 600**

Pre-assembled panels with 21 mm plywood. With Slip Boards, Cover Board and Crane Eyes 24.

**Note**

Panel h = 2.40 m, without Cover Board and Crane Eyes 24.  
 Permissible load-bearing point capacity 700 kg with crane sling angle  $\leq 15^\circ$ .

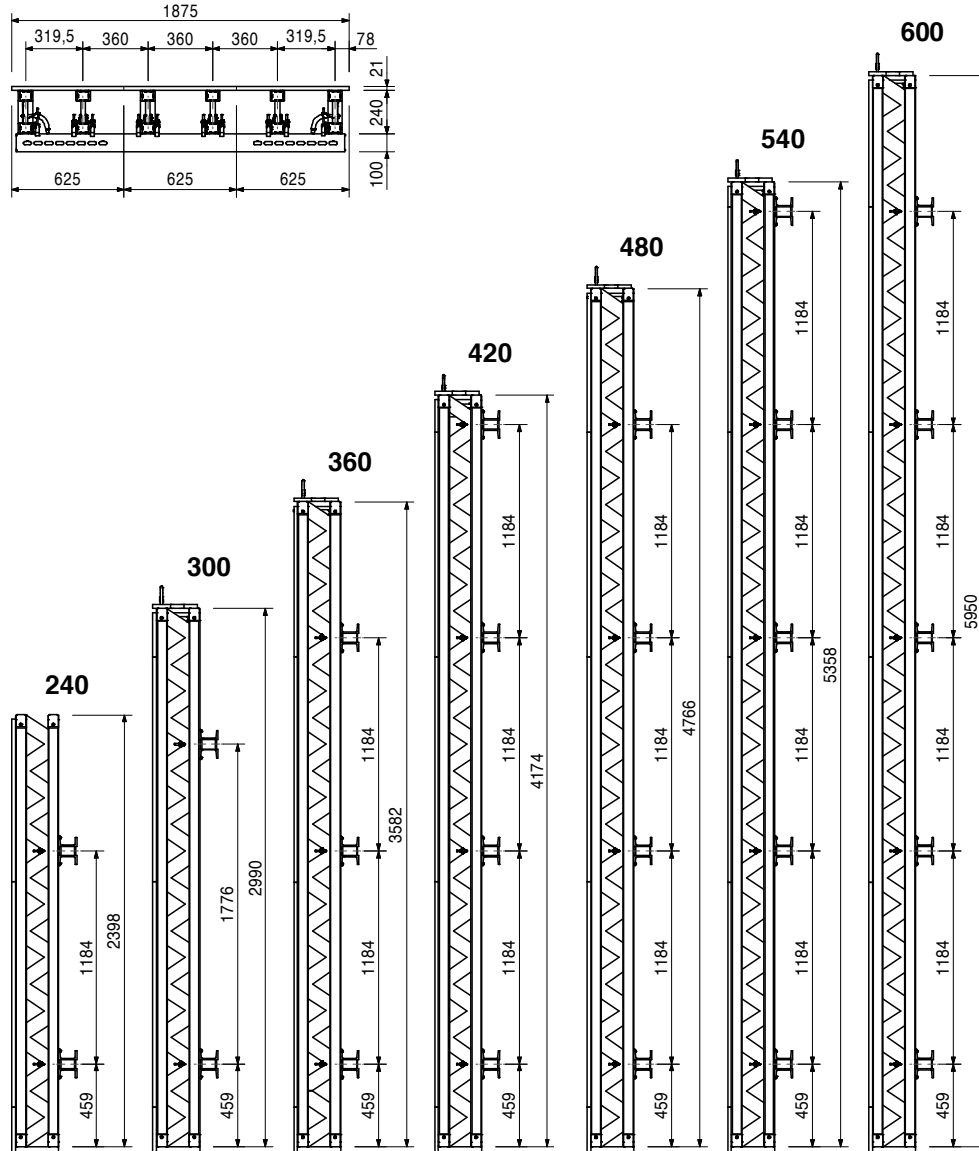

101318 4.470

**Protection Board 1875**

As top covering for VARIO GT 24 standard panels.

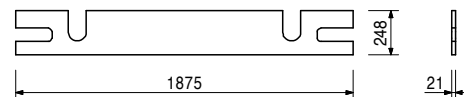
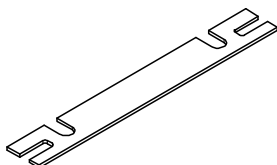

# VARIO GT 24 Girder Wall Formwork



Item no.	Weight kg
101255	173.000
101256	209.000
101257	267.000
101258	324.000
101259	352.000
101260	410.000
101261	438.000

- VARIO Standard Panels S b = 1.25 m**
- VARIO Standard Panel S 125 x 240**
- VARIO Standard Panel S 125 x 300**
- VARIO Standard Panel S 125 x 360**
- VARIO Standard Panel S 125 x 420**
- VARIO Standard Panel S 125 x 480**
- VARIO Standard Panel S 125 x 540**
- VARIO Standard Panel S 125 x 600**

Pre-assembled panels with 21 mm plywood. With Slip Boards, Cover Board and Crane Eyes 24.

**Note**

Panel h = 2.40 m, without Cover Board and Crane Eyes 24.  
Permissible load-bearing point capacity 700 kg with crane sling angle  $\leq 15^\circ$ .

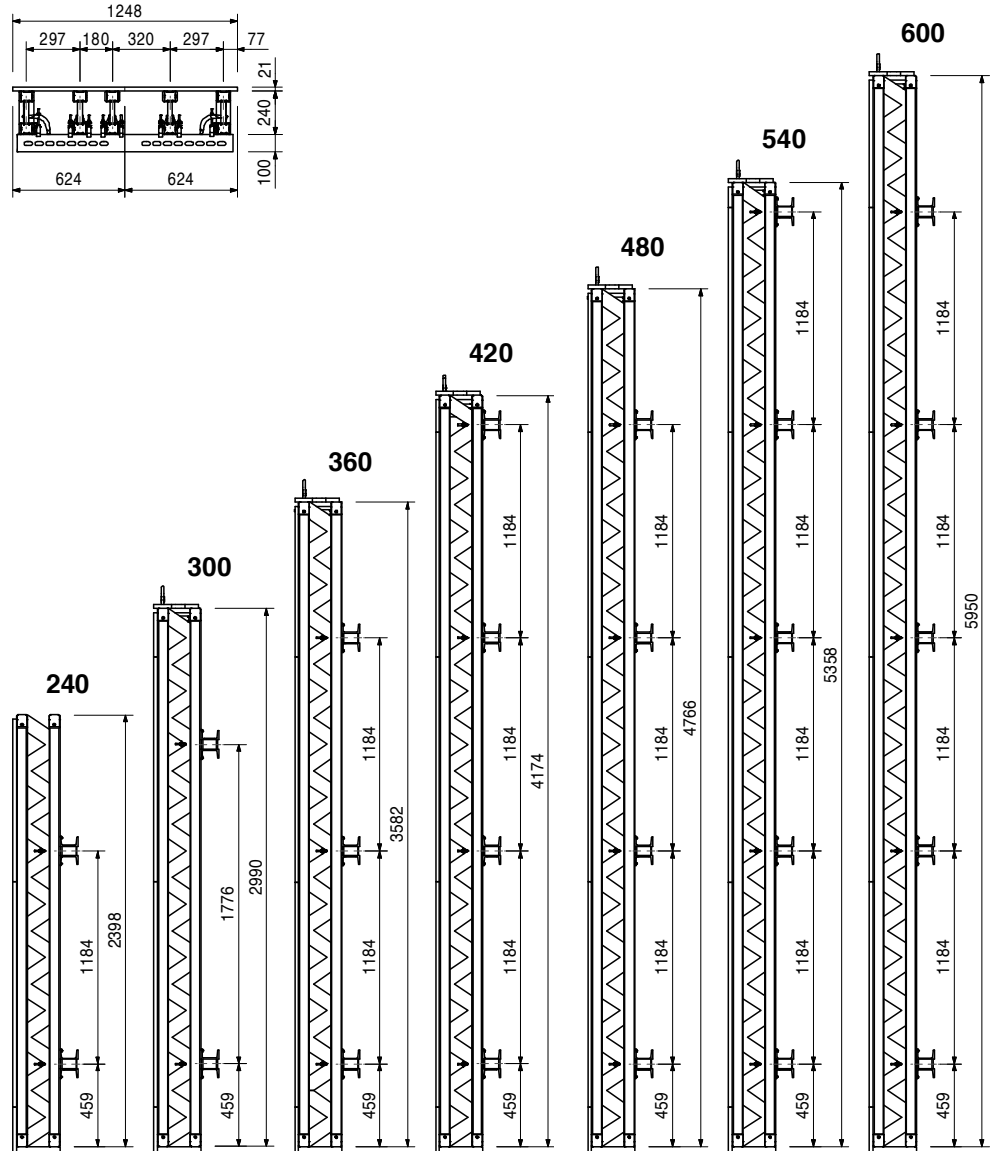

101319	2.860
--------	-------

**Protection Board 125**

As top covering for VARIO GT 24 standard panels.

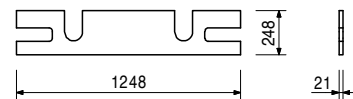
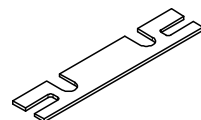

# VARIO GT 24 Girder Wall Formwork



Item no.	Weight kg
101411	138.000
101410	168.000
101409	214.000
101408	260.000
101407	283.000
101406	329.000
101405	351.000

**VARIO Standard Panels S b = 1.00 m**  
**VARIO Standard Panel S 100 x 240**  
**VARIO Standard Panel S 100 x 300**  
**VARIO Standard Panel S 100 x 360**  
**VARIO Standard Panel S 100 x 420**  
**VARIO Standard Panel S 100 x 480**  
**VARIO Standard Panel S 100 x 540**  
**VARIO Standard Panel S 100 x 600**

Pre-assembled panels with 21 mm plywood. With Slip Boards, Cover Board and Crane Eyes 24.

**Note**

Panel h = 2.40 m, without Cover Board and Crane Eyes 24.  
 Permissible load-bearing point capacity 700 kg with crane sling angle  $\leq 15^\circ$ .

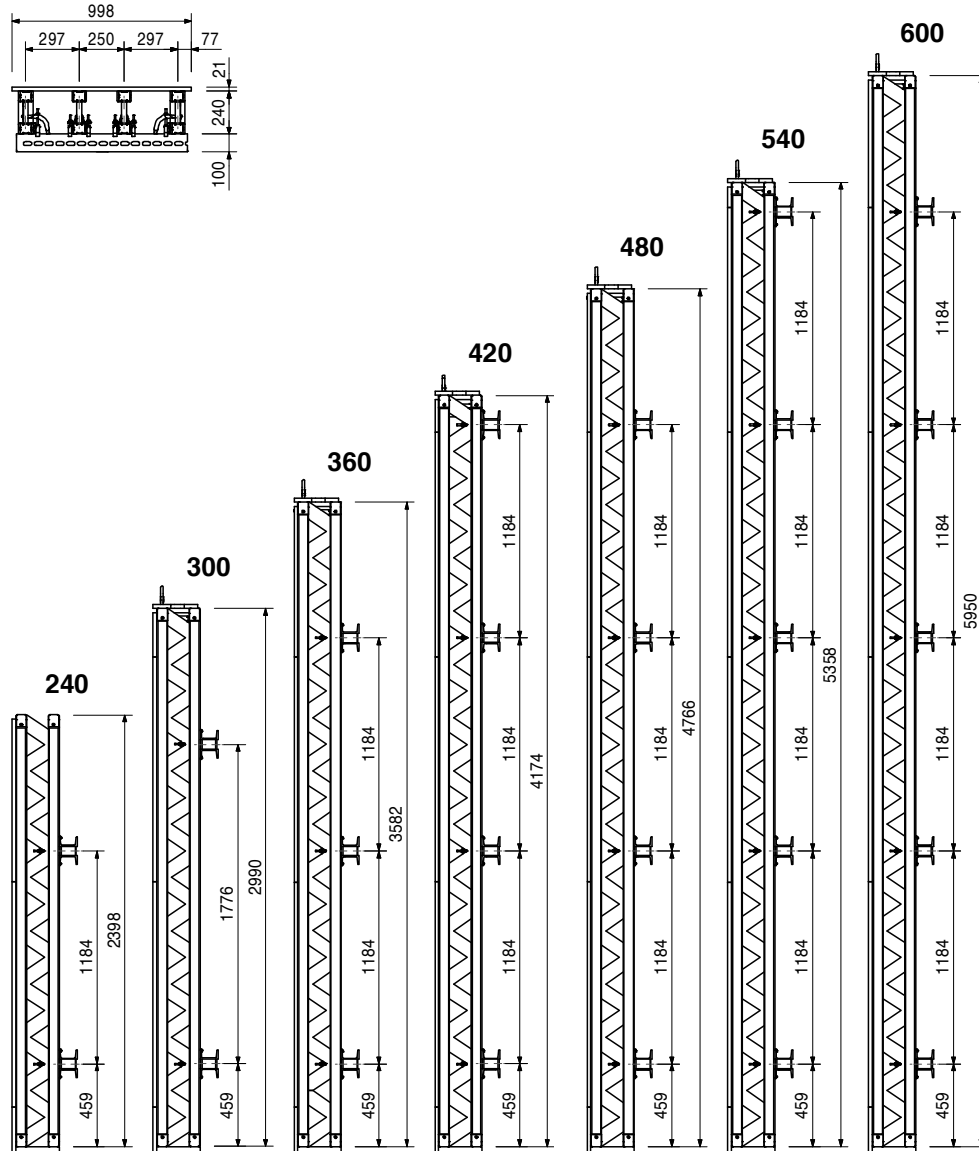

101404 2.230

**Protection Board 100**

As top covering for VARIO GT 24 standard panels.

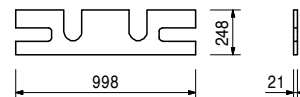
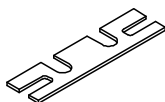

# VARIO GT 24 Girder Wall Formwork



Item no.	Weight kg
101471	214.000
101470	254.000
101469	328.000
101467	434.000
101465	539.000

- VARIO Internal Edges S 75/75**
- VARIO Internal Edge S 75/75 x 240**
- VARIO Internal Edge S 75/75 x 300**
- VARIO Internal Edge S 75/75 x 360**
- VARIO Internal Edge S 75/75 x 480**
- VARIO Internal Edge S 75/75 x 600**

Pre-assembled panels with 21 mm plywood. With Slip Boards, Cover Board and Crane Eyes 24.

**Note**

Panel h = 2.40 m, without Cover Board and Crane Eyes 24.

Permissible load-bearing point capacity 700 kg with crane sling angle  $\leq 15^\circ$ .

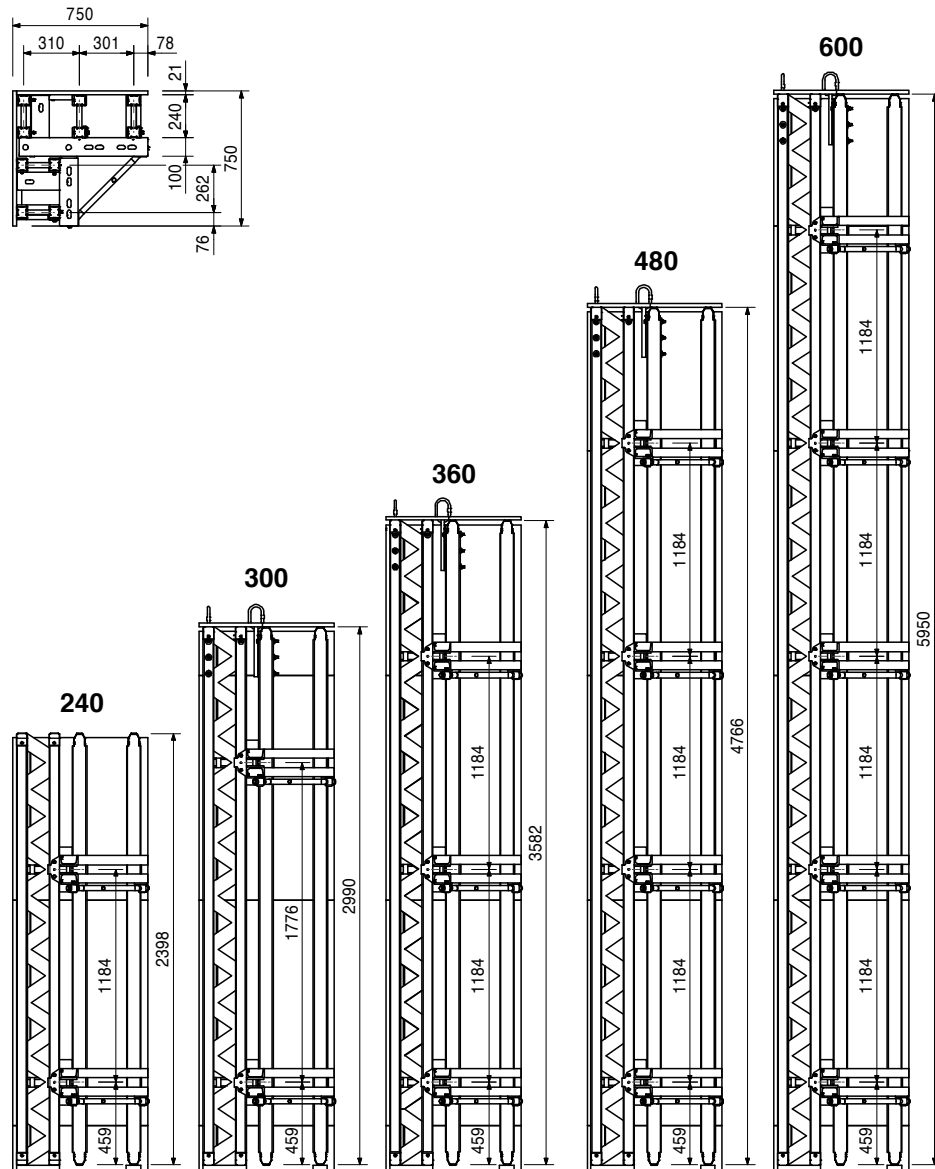

101464	4.730
--------	-------

**Protection Board IE 75/75**

As top covering for VARIO GT 24 standard panels.

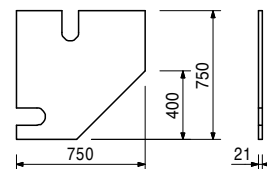

# VARIO GT 24 Girder Wall Formwork



Item no.	Weight kg
010600	19.800
010030	24.900
010610	30.400
010060	38.300
010070	40.900
010050	51.600
010120	61.500

**Steel Walers SRZ U100**  
**Steel Waler SRZ U100, l = 0.95 m**  
**Steel Waler SRZ U100, l = 1.20 m**  
**Steel Waler SRZ U100, l = 1.45 m**  
**Steel Waler SRZ U100, l = 1.825 m**  
**Steel Waler SRZ U100, l = 1.95 m**  
**Steel Waler SRZ U100, l = 2.45 m**  
**Steel Waler SRZ U100, l = 2.95 m**  
 Steel waler for VARIO GT 24 panels and special applications.

L
950
1200
1450
1825
1950
2450
2950

**Note**  
 Special lengths and other profile sizes on request.  
**Technical Data**  
 U100:  $W_y = 82.4 \text{ cm}^3$ ,  $I_y = 412 \text{ cm}^4$ .

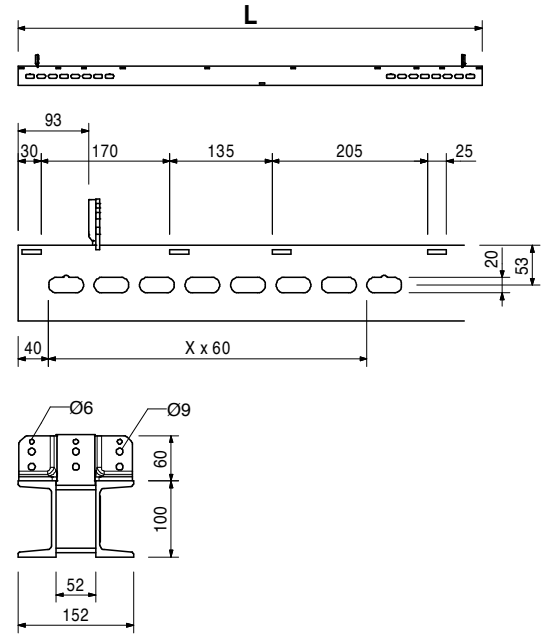
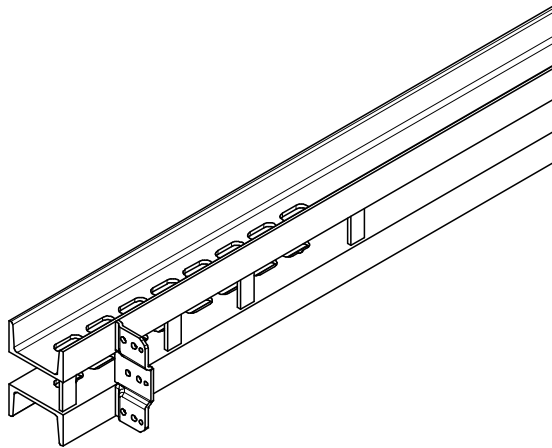

010080	22.000
010150	28.000
010090	33.000
010350	0.000

**Steel Walers SRZ spec. length**  
**Steel Waler SRZ U100 spec. length**  
**Steel Waler SRZ U120 spec. length**  
**Steel Waler SRZ U140 spec. length**  
**Additional Row of SRZ Slots**

**Technical Data**  
 U100:  $W_y = 82.4 \text{ cm}^3$ ,  $I_y = 412 \text{ cm}^4$ .  
 U120:  $W_y = 121.4 \text{ cm}^3$ ,  $I_y = 728 \text{ cm}^4$ .  
 U140:  $W_y = 172.8 \text{ cm}^3$ ,  $I_y = 1210 \text{ cm}^4$ .

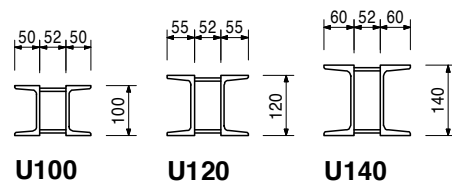

710001	0.370
--------	-------

**End Plate SRZ**  
 For Steel waler SRZ with special lengths.

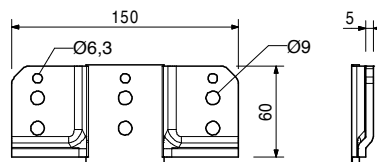
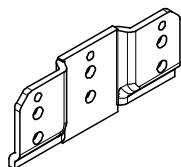

# VARIO GT 24 Girder Wall Formwork



Item no.	Weight kg
010440	32.100
010420	58.800
010490	0.000
010500	0.000

**Steel Walers VSRZ**  
**Steel Waler VSRZ-24 U100, I = 1.20/12**  
**Steel Waler VSRZ-24 U100, I = 2.45/12**  
**Welding Unit for VSRZ/12**  
**Welding Unit for VSRZ**  
 Steel waler for VARIO GT 24 corner panels and special applications.

**Note**  
 Special lengths and other profile sizes on request.  
**Technical Data**  
 $W_y = 82.4 \text{ cm}^3$ ,  $I_y = 412 \text{ cm}^4$ .

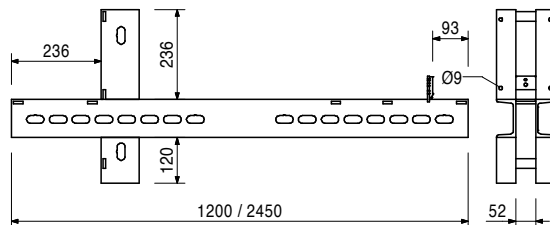
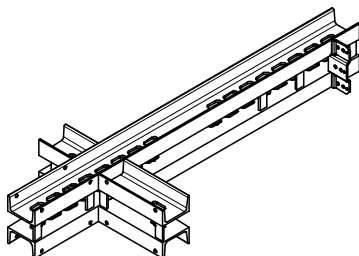

010240	22.000
010430	28.000
010250	33.000

**VARIO Walers VSRZ, spec. lenght**  
**VARIO Waler U100 VSRZ, spec. lenght**  
**VARIO Waler U120 VSRZ, spec. lenght**  
**VARIO Waler U140 VSRZ, spec. lenght**

**Note**  
 When ordering, state dimensions L1.  
**Technical Data**  
 U100:  $W_y = 82.4 \text{ cm}^3$ ,  $I_y = 412 \text{ cm}^4$ .  
 U120:  $W_y = 121.4 \text{ cm}^3$ ,  $I_y = 728 \text{ cm}^4$ .  
 U140:  $W_y = 172.8 \text{ cm}^3$ ,  $I_y = 1210 \text{ cm}^4$ .

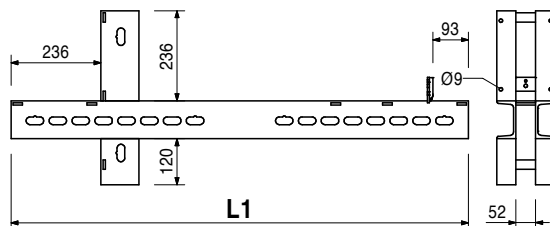

010200	42.300
--------	--------

**Internal Corner Waler IRZ 75/75**  
 Steel waler for VARIO GT 24 corner panel 75 x 75 cm. Allows easy striking.

**Technical Data**  
 $W_y = 82.4 \text{ cm}^3$ ,  $I_y = 412 \text{ cm}^4$ .

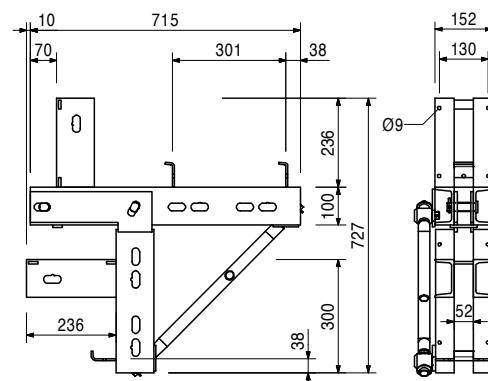
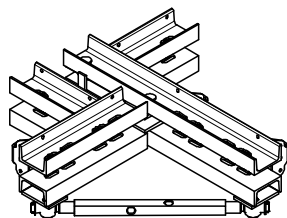

# VARIO GT 24 Girder Wall Formwork



Item no.	Weight kg
010180	22.000
010270	28.000
010190	33.000
010400	0.000

**Cross Walers KRZ spec. length**  
**Cross Waler KRZ U100, spec. length**  
**Cross Waler KRZ U120, spec. length**  
**Cross Waler KRZ U140, spec. length**  
**Welding Unit for KRZ**

Steel waler for VARIO GT 24 panels for narrow lift shafts.

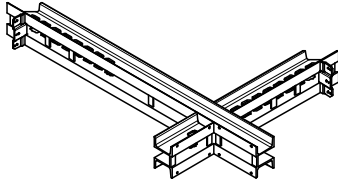

**Note**

When ordering, state dimensions L1 and L2.

**Technical Data**

U100:  $W_y = 82.4 \text{ cm}^3$ ,  $I_y = 412 \text{ cm}^4$ .

U120:  $W_y = 121.4 \text{ cm}^3$ ,  $I_y = 728 \text{ cm}^4$ .

U140:  $W_y = 172.8 \text{ cm}^3$ ,  $I_y = 1210 \text{ cm}^4$ .

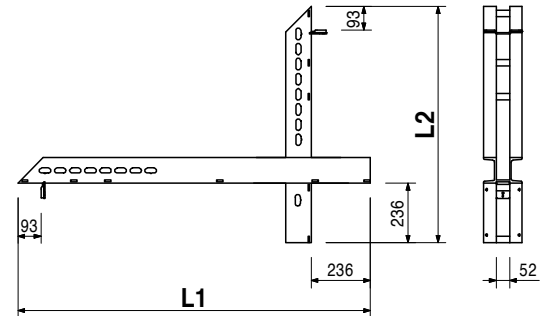

012150	38.700
012160	45.700

**Column Walers SSRZ-24 U-100**  
**Column Waler SSRZ-24 U-100, l = 0.97/0.85 m**  
**Column Waler SSRZ-24 U-100, l = 1.13/1.01 m**

For continuously adjustable column cross-sections 24 x 24 cm up to 48 x 60 cm or 40 x 40 cm up to 64 x 76 cm. Profile U100.

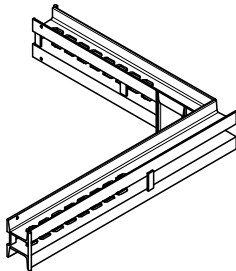

**Note**

Special lengths and other profile sizes available on request.

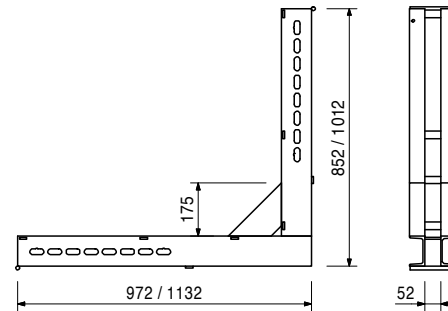

012050	31.300
--------	--------

**Column VARIO Waler SVRZ U-100, l = 1.20 m**

For continuously adjustable column cross-sections up to 80 x 120 cm in connection with Steel Waler SRU. Profile U100.

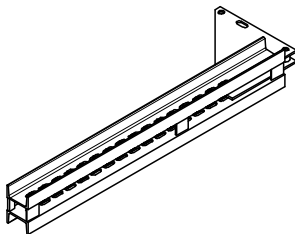

**Note**

Special lengths and other profile sizes available on request.

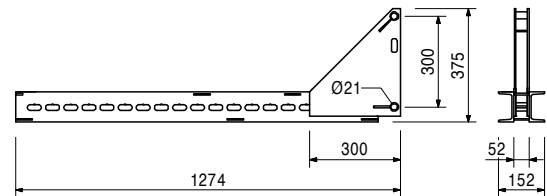

**Accessories**

103871	24.200
103874	30.900
103877	38.100
103886	44.700
037160	0.736
024240	0.805

**Steel Waler Universal SRU U120, l = 0.97 m**  
**Steel Waler Universal SRU U120, l = 1.22 m**  
**Steel Waler Universal SRU U120, l = 1.47 m**  
**Steel Waler Universal SRU U120, l = 1.72 m**  
**Bolt Ø 20 x 205, galv.**  
**Wedge KZ, galv.**

Item no.	Weight kg
103868	18.100
103871	24.200
103874	30.900
103877	38.100
103886	44.700
103889	52.000
103898	58.600
103892	65.600
103929	72.000
103903	81.000
103906	92.600
103915	106.000
103918	119.000
103922	135.000
103925	146.000
103928	159.000

Steel Walers Universal SRU	L
Steel Waler Universal SRU U120, l = 0.72 m	722
Steel Waler Universal SRU U120, l = 0.97 m	972
Steel Waler Universal SRU U120, l = 1.22 m	1222
Steel Waler Universal SRU U120, l = 1.47 m	1472
Steel Waler Universal SRU U120, l = 1.72 m	1722
Steel Waler Universal SRU U120, l = 1.97 m	1972
Steel Waler Universal SRU U120, l = 2.22 m	2222
Steel Waler Universal SRU U120, l = 2.47 m	2472
Steel Waler Universal SRU U120, l = 2.72 m	2722
Steel Waler Universal SRU U120, l = 2.97 m	2972
Steel Waler Universal SRU U120, l = 3.47 m	3472
Steel Waler Universal SRU U120, l = 3.97 m	3972
Steel Waler Universal SRU U120, l = 4.47 m	4472
Steel Waler Universal SRU U120, l = 4.97 m	4972
Steel Waler Universal SRU U120, l = 5.47 m	5472
Steel Waler Universal SRU U120, l = 5.97 m	5972

Universal Steel Waler Profile U120 used as waling for girder wall formwork and for diverse special applications. With adjustable spacers.

**Note**

Permissible load: see PERI Design Tables.

**Technical Data**

U120:  $W_y = 121.4 \text{ cm}^3$ ,  $I_y = 728 \text{ cm}^4$ .

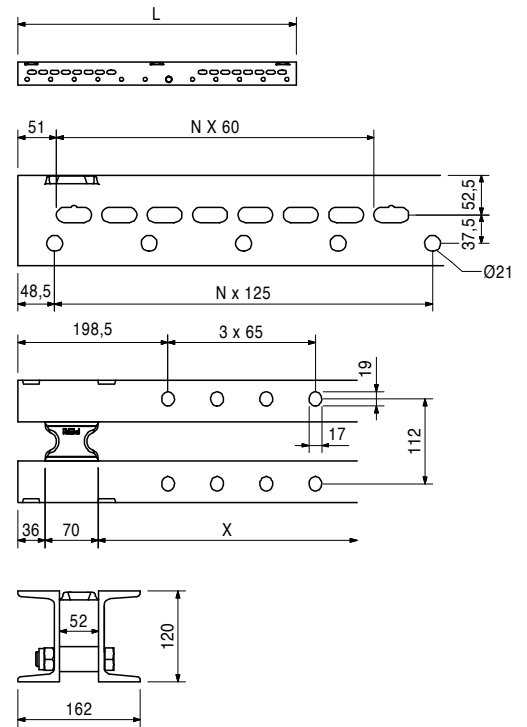
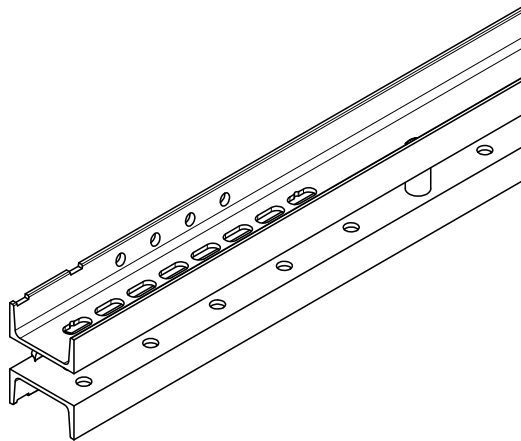

# VARIO GT 24 Girder Wall Formwork



Item no.	Weight kg
103943	157.000

**Steel Waler Universal SRU U140, l = 4.97 m**  
 Universal steel waler profile U140 used as waling for girder wall formwork and for diverse special applications. With adjustable spacers.

**Note**  
 Permissible load: see PERI Design Tables.  
**Technical Data**  
 U140:  $W_y = 172.8 \text{ cm}^3$ ,  $I_y = 1210 \text{ cm}^4$ .

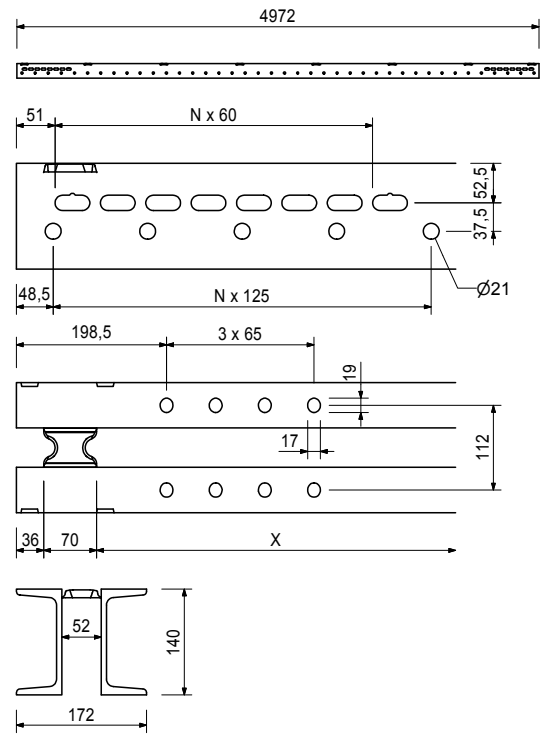
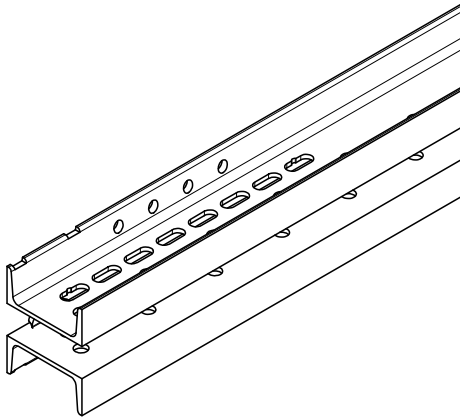

104027	7.610
--------	-------

**Extension VARIO 24 U120**  
 For assembly on Steel Waler SRU.

**Complete with**  
 4 pc. 710252 Bolt ISO 4017 M16 x 50-8.8, galv.  
 4 pc. 104024 Nut ISO 7040 M16-8, galv.  
 4 pc. 710880 Washer DIN 434 18, galv.  
**Technical Data**  
 U120:  $W_y = 121.4 \text{ cm}^3$ ,  $I_y = 728 \text{ cm}^4$ .

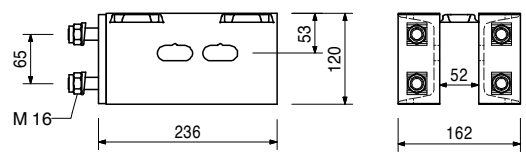
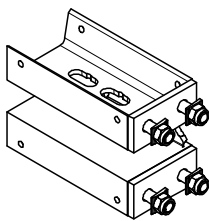

024070	0.691
--------	-------

**Hook Strap HB 24-100/120, galv.**  
 For fixing GT 24 Girders to Steel Walers SRZ, SRU and BR: U100 – U120.

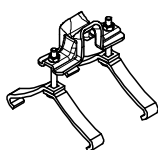
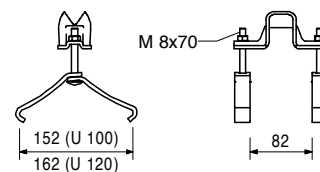

Item no.	Weight kg
024080	0.735

### Hook Strap HB 24-140/160, galv.

For fixing GT 24 Girders to Steel Walers SRZ, SRU and BR: U140 – U160.

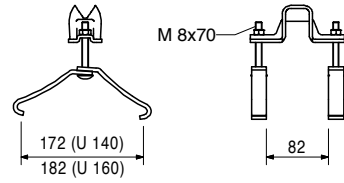
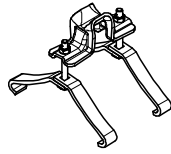

071218	0.000
126228	0.030
710240	0.050
024090	0.005

### Accessories Hook Straps HB

#### Screw Change HB, incl. Screws

F.H. Bolt DIN 603 M8 x 70 MU, galv.

F.H. Bolt DIN 603 M8 x 100 MU, galv.

Nut ISO 4032 M8-8, galv.

024600	0.907
--------	-------

### Girder Claw HB

For mounting the GT 24 Edge Girder on the Steel Waler SRZ and SRU Profile U100 – U120.

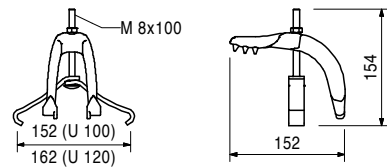
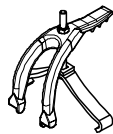

024630	0.742
--------	-------

### Fix Strap U100 – U120, galv.

For fixing the GT 24 Girder in the VARIO Corner.

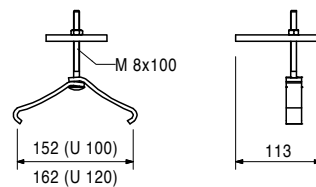
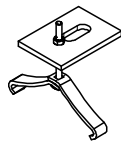

024640	0.923
--------	-------

### Quick Str. Hook Strap 24-100/140, galv.

For fixing GT 24 Girders to Steel Waler SRZ, SRU, Profile U100 – U140 outside of the girder nodes.

### Note

Girders fixed in position with the quick strap must be specially screwed to the formlining when using crane lifting gears.

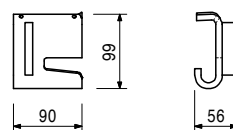
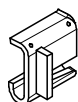

Item no.	Weight kg
----------	-----------

104931	0.865
103845	0.893

**Hook Straps Uni HBU**  
**Hook Strap Uni HBU 20-24**  
**Hook Strap Uni HBU 24-28**

For fixing GT 24 Girders or VT 20 Girders to Steel Walers SRZ and SRU Profiles U100 – U140.

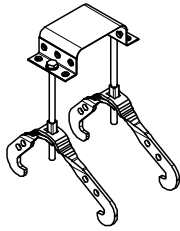

**Note**

The girders can be mounted at right-angles or diagonally to the steel walers and also outside of the nodes.

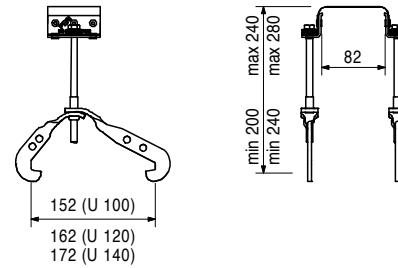

Accessories

024540	0.005
--------	-------

**TSS-Torx 6 x 40, galv.**

**Hook Straps Uni Double HBUD**  
**Hook Strap Uni Double HBUD 20-24**  
**Hook Strap Uni Double HBUD 24-28**

For fixing two GT 24 Girders or VT 20 Girders to SRZ Steel Walers and SRU Profiles U100 – U140.

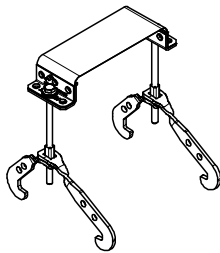

**Note**

The girders can be mounted at right-angles or diagonally to the steel walers and also outside of the nodes.

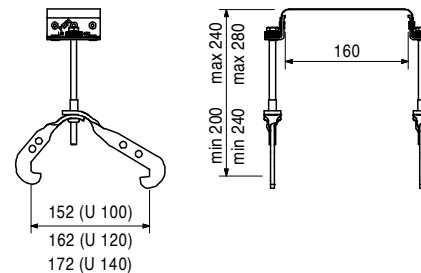

071219	0.000
104929	0.050
107185	0.060
103518	0.060
103844	0.013

**Accessories Hook Straps HBU, HBUD**  
**Screw Change HBU, HBUD**  
**Bolt ISO 4014 M8 x 150-8.8, galv.**  
**Bolt ISO 4014 M8 x 180-8.8, galv.**  
**Bolt ISO 4014 M8 x 190-8.8, galv.**  
**Sleeve HBU/HBUD, galv.**

024860	0.616
--------	-------

**Hook Strap HB 24 QB 150, galv.**

For fixing GT 24 Girders independent from girder node and timber beams to Steel Walers SRZ, SRU and BR: U100 – U120.

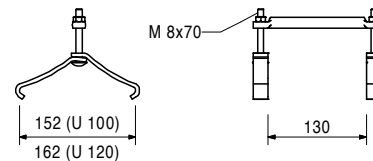
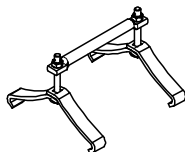

Item no.	Weight kg	
024470	0.008	<b>TSS-Torxs, galv.</b>
024690	0.008	<b>TSS-Torx 6 x 60, galv.</b>
		<b>TSS-Torx 6 x 80, galv.</b>

For Torx Blade TX 30. Self-drilling.

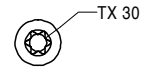
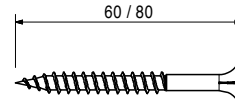
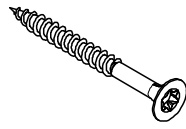

110272	0.006	<b>TSS-Torx 6 x 60, ZKS, galv.</b>
--------	-------	------------------------------------

For Torx Blade TX 30. Self-drilling.

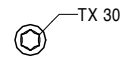
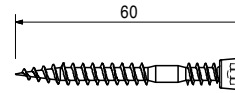
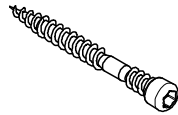

024270	0.023	<b>Lag Screws DIN 571, galv.</b>
024260	0.027	<b>Lag Screw DIN 571 8 x 60, galv.</b>
		<b>Lag Screw DIN 571 8 x 80, galv.</b>

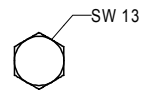
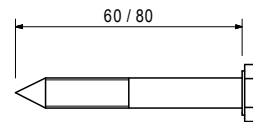
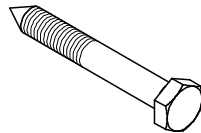

128013	2.100	<b>Cordless Combi Drill ABS 18</b>	<b>Note</b>
Universal power screwdriver with continuous electronic speed control and clockwise/anti-clockwise rotation. Including 2 batteries and a battery charger in case.			Follow Instructions for Use!



		Accessories
072220	0.400	<b>Bit Holder for SCU 7-9</b>
072140	0.005	<b>Bit Point TX 30</b>
128016	0.760	<b>Replacement Battery Li-Ion 18V</b>

		<b>Accessories Cordless Combi Drill ABS 18</b>
072220	0.400	<b>Bit Holder for SCU 7-9</b>
072140	0.005	<b>Bit Point TX 30</b>

Item no.	Weight kg
128011	1.800

**Cordless Impact Screwdriver ASCD 18-W2**

Light weight electric power wrench for moment-free working, with clockwise/anti-clockwise rotation and 1/2 square drive. Including 2 batteries and a battery charger in case.

**Note**  
Follow Instructions for Use!



128016	0.760
--------	-------

**Replacement Battery Li-Ion 18V**

For use with Cordless Combi Drill ABS 18 and Cordless Impact Screwdriver ASCD 18-W2.

**Note**  
Follow Instructions for Use!  
**Technical Data**  
Capacity 4 Ah.



072180	0.560
--------	-------

**Ratchet Wrench 1/2"**

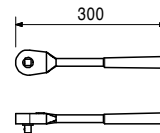
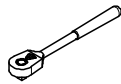

030370	1.660
--------	-------

**Wingnut Pivot Plate DW 15, galv.**

For anchoring with Tie Rod DW 15 and B 15. With pivoting captive nut. Maximum angle of tilting 8°.

**Note**  
Wrench size SW 27.  
**Technical Data**  
Permissible load 90 kN.

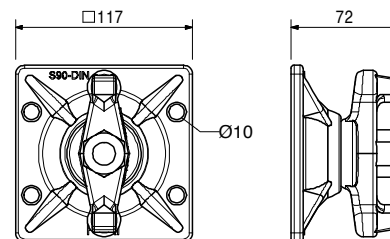
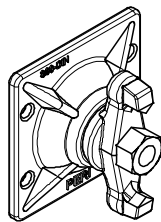

Item no.	Weight kg
030030	1.440
030050	0.000

**Tie Rod DW 15**  
**Tie Rod DW 15, spec. length**  
**Cutting Cost Tie Rod DW 15, B 15**

**Note**  
 Non-weldable! Take official Approval into consideration!

**Technical Data**  
 Permissible tension force 90 kN.

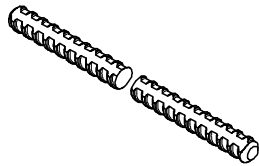

065027	0.359
--------	-------

**Spacer Tube rough DR 22, l = 2.00 m**  
 Plastic Spacer Tube for DW 15, B 15.

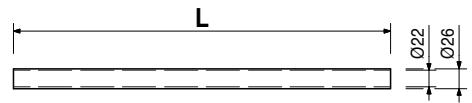
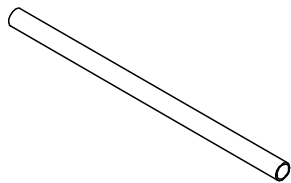

031050	1.780
--------	-------

**Tie Rod Wrench 20, galv.**  
 For easy handling of Tie Rod DW 20.

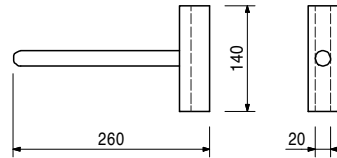
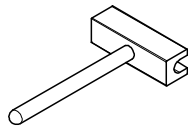

065036	0.002
--------	-------

**Plug DR 22**  
 Plastic. Suitable for Spacer Tube DR 22.

**Note**  
 Delivery unit 1000 pieces.

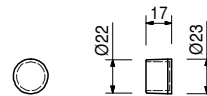

065033	0.010
--------	-------

**Cone DR 22**  
 Plastic. Suitable for Spacer Tube DR 22.

**Note**  
 Delivery unit 500 pieces.

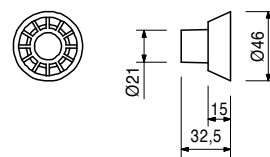

Item no.	Weight kg
013010	9.000
013020	13.300
013030	19.100
013080	9.000

### Couplings VKZ

**Coupling VKZ 99**

**Coupling VKZ 147**

**Coupling VKZ 211**

**Coupling VKZ spec. length**

For connection of SRZ and SRU Steel Walers.

**L**

990

1470

2110

### Technical Data

$W_y = 17.1 \text{ cm}^3$ ,  $I_y = 68.3 \text{ cm}^4$ .

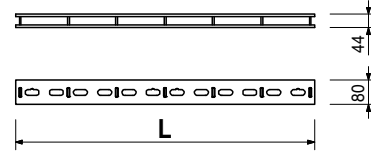
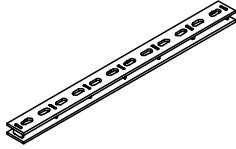

101395	7.110
--------	-------

### Offset Coupling VVKZ 3/99

For connecting extended and non-extended VARIO panels above the extension.

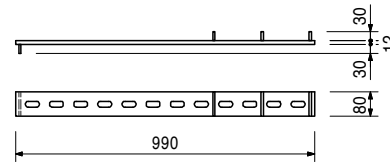
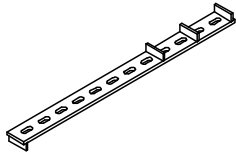

013140	11.900
013130	13.300
103938	8.850
013180	9.000

### Corner Couplings EKZ

**Corner Coupling EKZ 95/43**

**Corner Coupling EKZ 76/76**

**Corner Coupling EKZ 47/43**

**Corner Coupling EKZ spec. length**

For continuously variable tight (tension and compression) connection of SRZ and SRU Steel Walers.

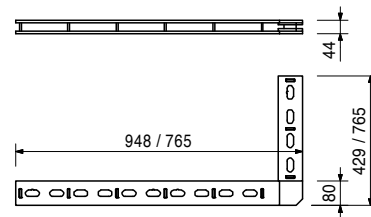
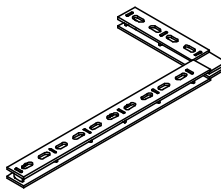

Item no.	Weight kg
103850	24.700

## Outside Corner Coupling AKZ 85/85

For providing tensile and compression-proof connections of Steel Walers SRZ and SRU on external corners.

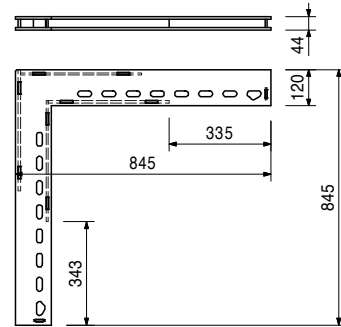
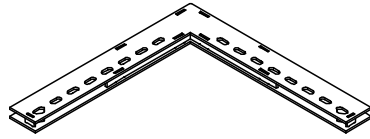

013220	11.500
013210	14.400
013230	9.000

## Articulated Couplings GKZ

### Articulated Coupling GKZ 60/60

### Articulated Coupling GKZ 76/76

### Articulated Coupling GKZ spec. length

For continuously variable tight (tension and compression) connection of SRZ and SRU Steel Walers with oblique angles more than 48°.

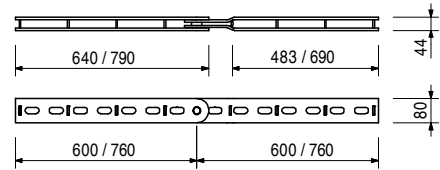
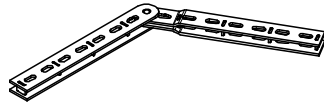

102825	8.610
--------	-------

## VARIO Coupling Concrete Finish VKS 99

For connecting VARIO GT 24 panels. Allows compensation of up to max. 5 mm panel offsets.

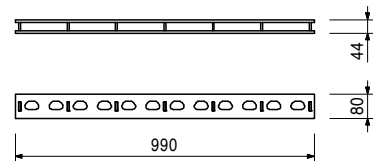
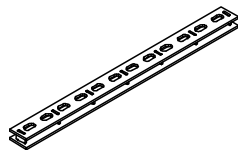

102945	2.070
--------	-------

Accessories

## VARIO Alignment Clamp VRS

Item no.	Weight kg
103054	11.200

## Articulated Coupling GKS 60/60 S

For connecting VARIO GT 24 panels. Allows compensation of up to max. 5 mm panel offsets.

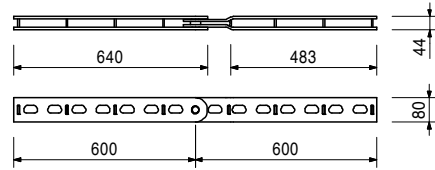
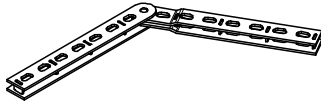

Accessories

102945	2.070
--------	-------

## VARIO Alignment Clamp VRS

102945	2.070
--------	-------

## VARIO Alignment Clamp VRS

In connection with Coupling VKS 99 or Articulated Coupling GKS 60/60. For compensating maximum 5 mm element offset.

### Complete with

1 pc. 030370 Wingnut Pivot Plate DW 15, galv.

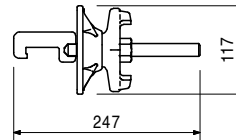
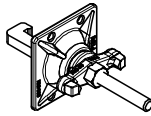

103737	10.800
--------	--------

## Universal Coupling UK 70

For a rigid connection of Steel Walers SRU and for connecting Heavy-Duty Spindles SLS.

### Note

Permissible load: see PERI Design Tables.

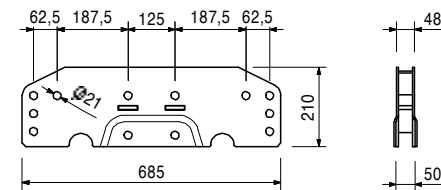
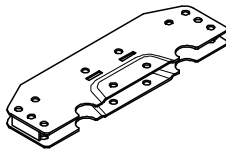

Accessories

104031	0.462
018060	0.014

## Fitting Pin Ø 21 x 120

Cotter Pin 4/1, galv.

104031	0.462
--------	-------

## Fitting Pin Ø 21 x 120

For different connections.

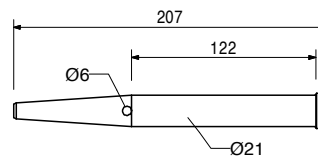
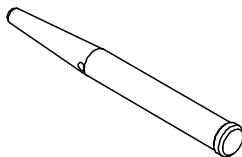

Accessories

018060	0.014
--------	-------

Cotter Pin 4/1, galv.

Item no.	Weight kg
018060	0.014

**Cotter Pin 4/1, galv.**



024210	2.180
--------	-------

**Tie Yoke SKZ**

For tensioning on external corners with Steel Waler SRZ, SRU, U100 – U140 and VARIO couplings.

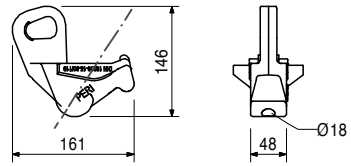
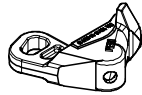

013240	2.100
--------	-------

**Stopend Tie**

For assembling stopend formwork with VARIO GT 24.

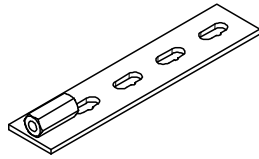

**Technical Data**

Permissible tension force 30.0 kN.

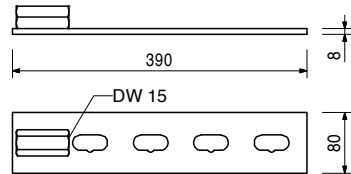

024240	0.805
--------	-------

**Wedge KZ, galv.**

For connecting panels with VARIO Couplings or Tie Yoke SKZ.

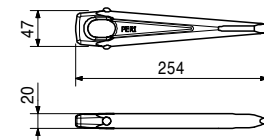

# VARIO GT 24 Girder Wall Formwork



Item no.	Weight kg
024220	1.230

## Coupling Compression Plate KDP

For mounting girders to VARIO Couplings in infill areas.

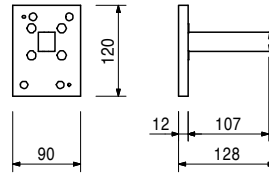
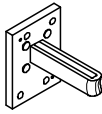

024250	0.331
--------	-------

## Wedge K, galv.

For Coupling Compression Plate KDP, Wedge Head Piece SRZ/SRU and Waler Connector SB-A, B, C.

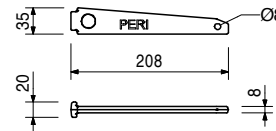

031200	0.470
--------	-------

## Chamfer Strip with Flange, l = 2.50 m

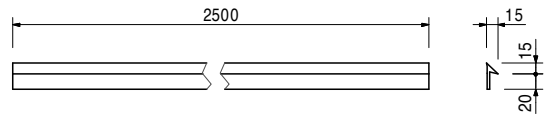
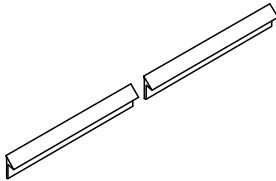

030260	0.500
101706	1.230

## Formwork Joints

### Formwork Joint 21/20, l = 2.50 m

### Formwork Joint 21/40, l = 3.00 m

Plastic profile strip for easier striking of shafts.

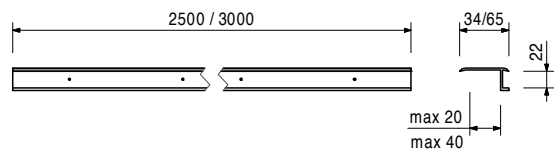
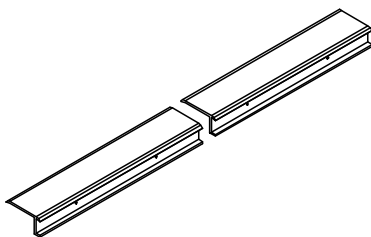

# VARIO GT 24 Girder Wall Formwork



Item no.	Weight kg
025200	32.200
025210	70.000
025220	105.000
025230	140.000
025240	180.000
025250	35.000

## Quick Release Corners SSE

**Quick Release Corner SSE 1.0 m**

**Quick Release Corner SSE 2.0 m**

**Quick Release Corner SSE 3.0 m**

**Quick Release Corner SSE 4.0 m**

**Quick Release Corner SSE 5.0 m**

**Quick Release Corner SSE spec. length**

For easier striking of shaft internal formwork. We recommend removing the shaft corner immediately after concreting.

**L**

1000

2000

3000

4000

5000

### Note

Formlining size is 15 cm shorter than the dimension of the concrete.

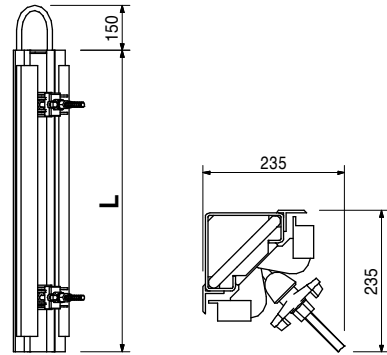
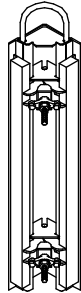

027590 2.400

## Hook Strap for SB-1, 2

For fixing Brace Frame SB-1 and SB-2 to Steel Waler SRZ and SRU Profile U100 – U140.

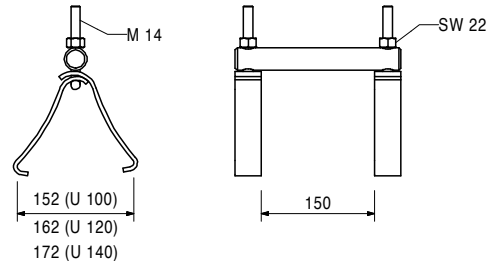
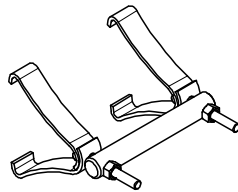

024480 7.040

## Extension Splice 24-2

For extending GT 24 girders and VARIO GT 24 panels up to max. height of 8.00 m.

### Complete with

2 pc. 030190 Three Wingnut DW 15, galv.

### Note

Permissible load: see PERI Design Tables.

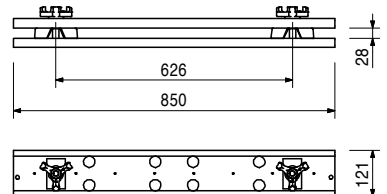

Item no.	Weight kg
070760	4.650

### Crane Splice GT 24

For transporting elements by crane with the GT 24 girder.

### Complete with

- 1 pc. 018050 Pin Ø 16 x 65/86, galv.
- 1 pc. 018060 Cotter Pin 4/1, galv.

### Note

Follow Instructions for Use!

### Technical Data

Permissible load-bearing capacity 700 kg with crane sling angle  $\leq 15^\circ$ .

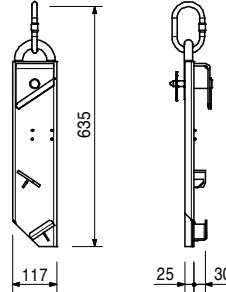
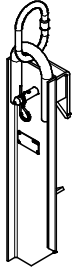

021990	2.780
021980	2.780

### Crane Eyes 24

#### Crane Eye 24, right

#### Crane Eye 24, left

For transporting elements by crane with the GT 24 girder. Mounted securely to the element.

### Complete with

- 4 pc. 710138 Bolt ISO 4014 M10 x 110-8.8, galv.
- 4 pc. 780356 Nut ISO 7042 M10-8, galv.
- 4 pc. 710139 Washer R11 DIN 440, galv.

### Note

Illustration shows Crane Eye 24, left. Follow Instructions for Use!

### Technical Data

Permissible load-bearing capacity 700 kg with crane sling angle  $\leq 15^\circ$ .

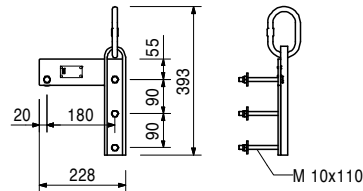
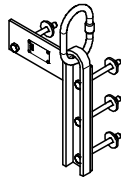

111238	19.800
--------	--------

### Crane Hook 2 t / GT 24

For transporting elements by crane with the GT 24 Girder. Adjustable from 230 to 410 mm.

### Complete with

- 1 pc. 018060 Cotter Pin 4/1, galv.
- 8 pc. 710138 Bolt ISO 4014 M10 x 110-8.8, galv.
- 8 pc. 780356 Nut ISO 7042 M10-8, galv.

### Note

Follow Instructions for Use!

### Technical Data

Permissible load-bearing capacity 2.0 t with crane sling angle  $\leq 30^\circ$ .

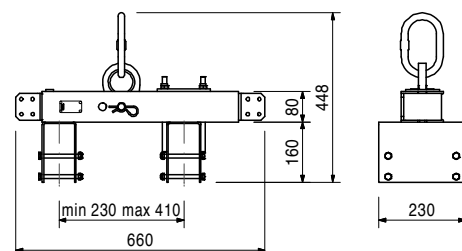
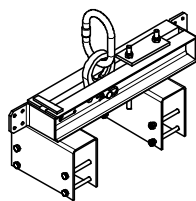

Item no.	Weight kg
027110	11.000

### Scaffold Bracket GB 80

For assembly of a working and concreting scaffold with GT 24 girder.

### Technical Data

Permissible load 150 kg/m<sup>2</sup>. Maximum width of influence 1.25 m.

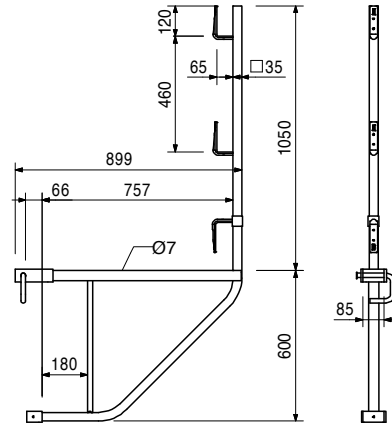
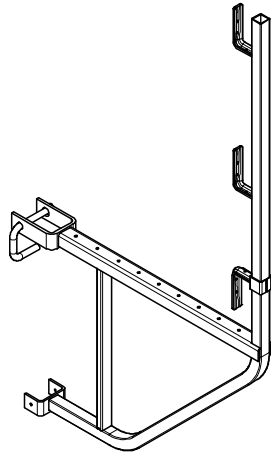

027060	13.800
027070	13.800

### Corner Scaffold Brackets EGB

#### Corner Scaffold Bracket EGB 24 – 80, right

#### Corner Scaffold Bracket EGB 24 – 80, left

For assembling a working scaffold to panels with GT 24 Girders. With securing bolts.

### Note

Illustration shows Corner Scaffold Bracket EGB 24 – 80 right.

### Technical Data

Permissible load 150 kg/m<sup>2</sup> with a maximum width of influence 1.25 m.

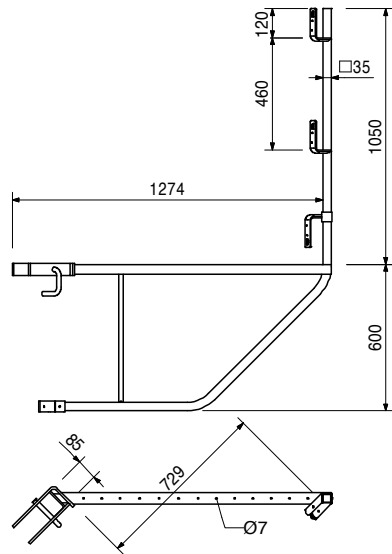
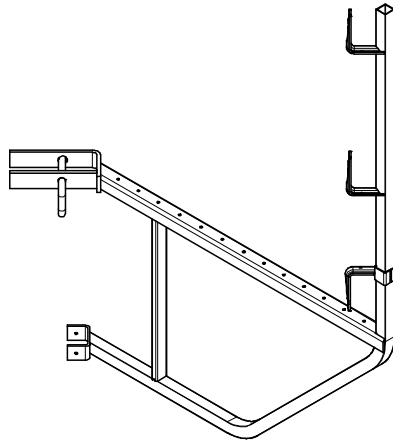

# VARIO GT 24 Girder Wall Formwork



Item no.	Weight kg
112159	2.120

**Handrail Post Holder VARIO**  
For assembling a guardrail with GT 24 Girder.

**Complete with**  
1 pc. 024250 Wedge K, galv.  
1 pc. 780800 Sleeve ISO 8752 8 x 20, galv.  
**Technical Data**  
Maximum width of influence 2.00 m.

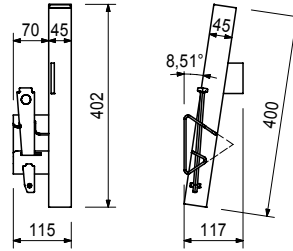
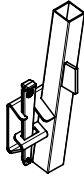

Accessories

116292	4.720
--------	-------

**Guardrail Post HSGP-2**

116292	4.720
--------	-------

**Guardrail Post HSGP-2**  
As guardrail for different systems.

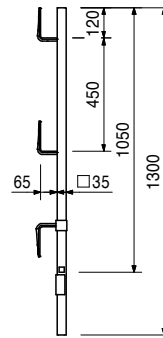

105985	156.000
--------	---------

**Platform VARIO 100 x 250 with Hatch**  
Pre-assembled working platform for VARIO GT 24 panels.

**Complete with**  
2 pc. 100813 Platform Guardrail 80  
**Technical Data**  
Permissible load 150 kg/m<sup>2</sup>.

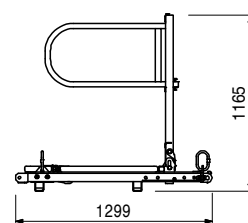
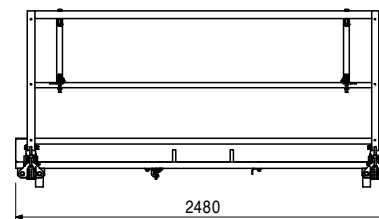
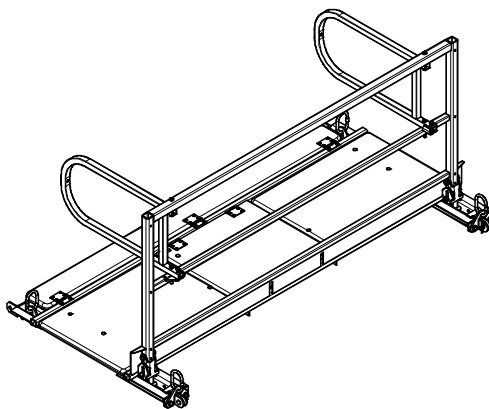

# VARIO GT 24 Girder Wall Formwork

Item no.	Weight kg
102415	98.800

**Platform VARIO 100 x 125 with Hatch**  
 Pre-assembled working platform for VARIO GT 24 panels.

**Technical Data**  
 Permissible load 150 kg/m<sup>2</sup>.

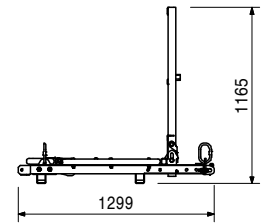
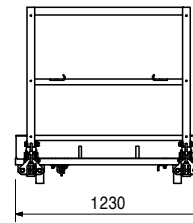
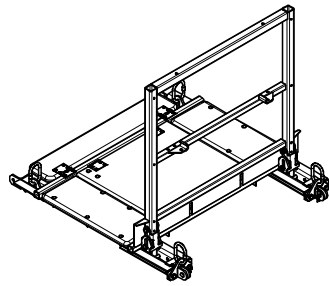

Accessories

100813	4.980
--------	-------

**Platform Guardrail 80**

105986	155.000
--------	---------

**Platform VARIO 100 x 250 without Hatch**  
 Pre-assembled working platform for VARIO GT 24 panels.

**Complete with**  
 2 pc. 100813 Platform Guardrail 80

**Technical Data**  
 Permissible load 150 kg/m<sup>2</sup>.

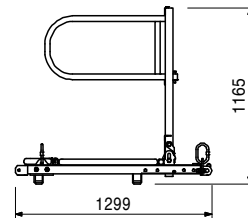
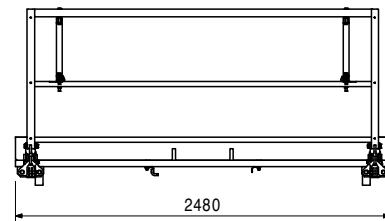
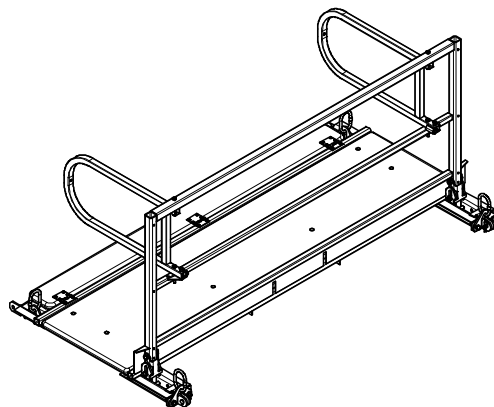

# VARIO GT 24 Girder Wall Formwork

Item no.	Weight kg
102920	115.000
103203	84.900

**Platforms VARIO without Hatch**  
**Platform VARIO 100 x 187.5**  
**Platform VARIO 100 x 100**  
 Pre-assembled working platform for VARIO GT 24 panels.

**Technical Data**  
 Permissible load 150 kg/m<sup>2</sup>.

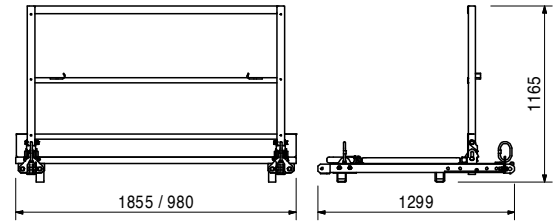
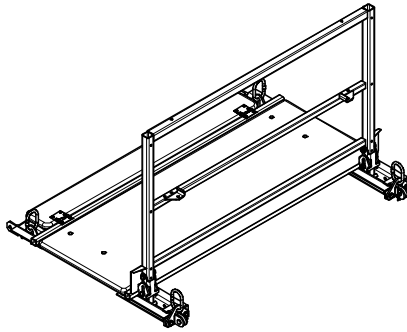

Accessories  
**Platform Guardrail 80**

100813	4.980
--------	-------

**End Platform VARIO**  
 Pre-assembled working platform for VARIO GT 24 stopend formwork. 2 pieces per set of stopend formwork and platform level.

**Technical Data**  
 Permissible load 150 kg/m<sup>2</sup>.

103932	36.300
--------	--------

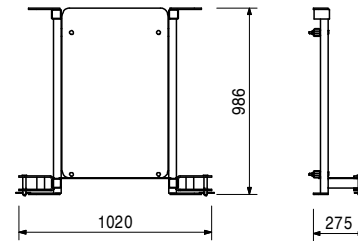
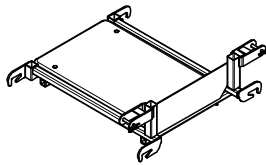

Accessories  
**Guardrail for End Platform VARIO**

103865	22.000
--------	--------

**External Corner Platform VARIO**  
 Pre-assembled working platform for VARIO GT 24 panels. Connecting platform with pivot-mounted end handrail. For external corners from 80° to 100°.

**Technical Data**  
 Permissible load 150 kg/m<sup>2</sup>.

103992	65.600
--------	--------

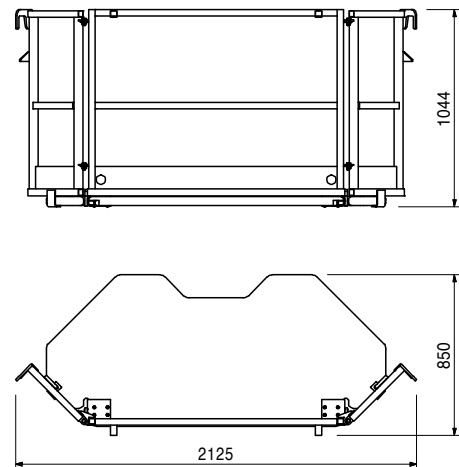
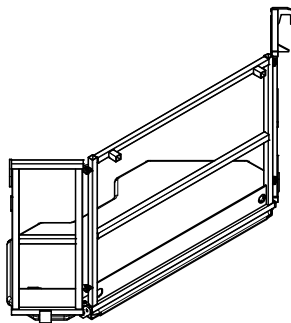

Item no.	Weight kg
103865	22.000

## Guardrail for End Platform VARIO

For assembly on VARIO End Platform with wall thicknesses up to 0.50 m. With foldable VARIO Platform Handrail 80.

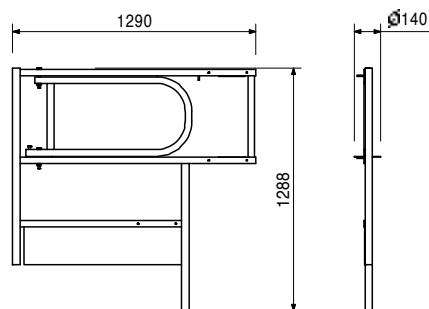
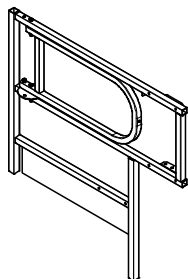

100813	4.980
--------	-------

## Platform Guardrail 80

End handrail for various platforms. Pivot-mounted.

### Complete with

2 pc. 102414 Bolt  $\varnothing$  12 x 105 x 5 x 95-ST, galv.  
2 pc. 018060 Cotter Pin 4/1, galv.

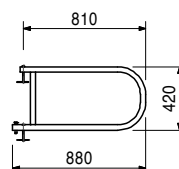
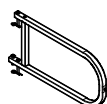

100541	4.020
--------	-------

## Connector for Platform VARIO

For connecting the VARIO platforms and platform struts to GT 24 girders.

### Complete with

1 pc. 027170 Pin  $\varnothing$  16 x 42, galv.  
1 pc. 018060 Cotter Pin 4/1, galv.

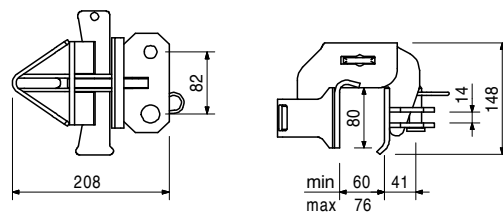
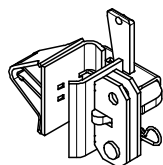

# VARIO GT 24 Girder Wall Formwork



Item no.	Weight kg
101273	7.780
101269	11.200

**Platform Struts VARIO**  
**Platform Strut VARIO 167**  
**Platform Strut VARIO 246**

For assembling VARIO platforms. 2 pieces per platform.

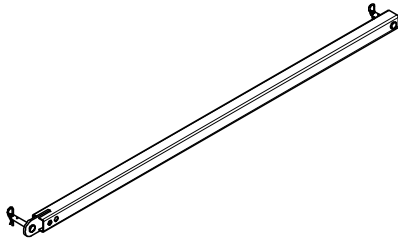

**Complete with**

2 pc. 018050 Pin Ø 16 x 65/86, galv.  
 2 pc. 018060 Cotter Pin 4/1, galv.

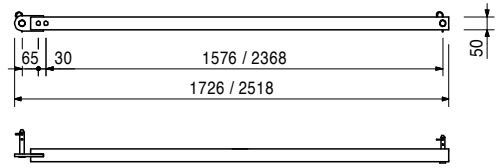

105480	16.600
105484	16.600

**Platform Beams VARIO**  
**Platform Beam VARIO, left**  
**Platform Beam VARIO, right**

For assembling VARIO GT 24 filler platforms with bolted boarding.

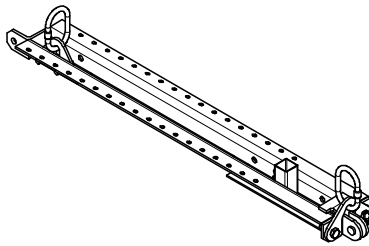

**Note**

Illustration shows the VARIO Platform Beam, left.

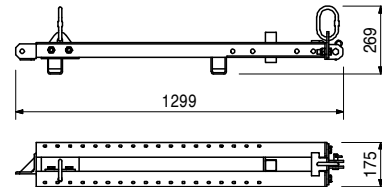

105823	9.310
--------	-------

**Platform Bracket VARIO VBK 90**

For assembly of a working and concreting scaffold on elements with GT 24 girders. With safety pins and cotter pins.

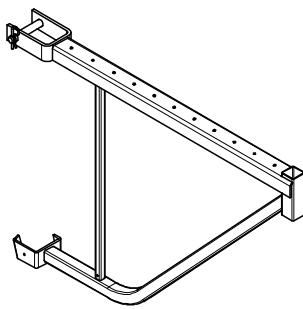

**Complete with**

1 pc. 106336 Bolt Ø 20 x 120, galv.  
 1 pc. 018060 Cotter Pin 4/1, galv.

**Technical Data**

Permissible load 150 kg/m<sup>2</sup> with a maximum width of influence 1.25 m.

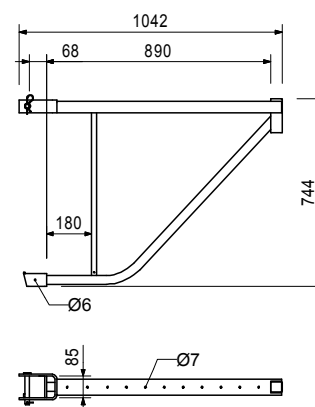

Accessories

116292	4.720
--------	-------

**Guardrail Post HSGP-2**

# VARIO GT 24 Girder Wall Formwork

Item no.	Weight kg
107738	24.100

**Ladder 240 – 360**  
Adjustable from 2.40 m to 3.60 m.

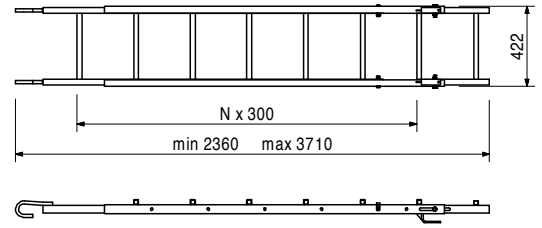
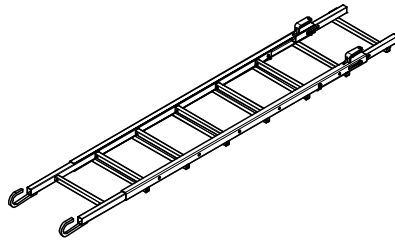

111165	6.080
--------	-------

**Ladder Connector VARIO, adjustable**  
For connecting ladders to Steel Walers SRZ and SRU, Profile U100 – U120.

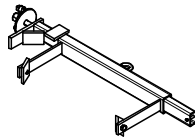

**Complete with**  
2 pc. 710266 Bolt ISO 4017 M12 x 25-8.8, galv.  
2 pc. 701763 Clamping Plate FI 25 x 10 x 90

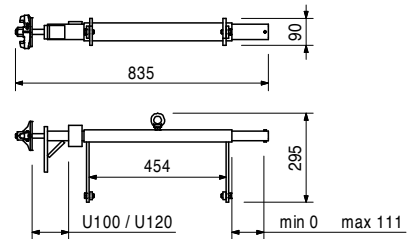

051410	11.700
--------	--------

**Ladder 180/6, galv.**  
As access for PERI Formwork Systems.

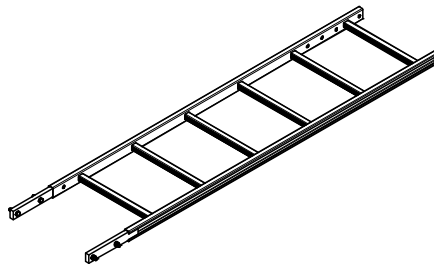

**Complete with**  
4 pc. 710224 Bolt ISO 4017 M12 x 40-8.8, galv.  
4 pc. 710381 Nut ISO 7042 M12-8, galv.

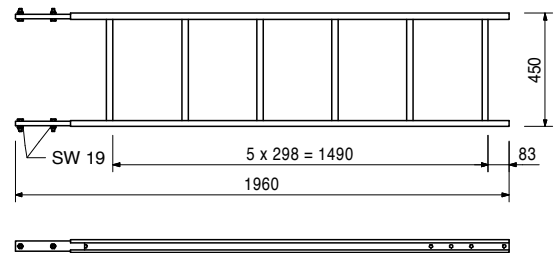

103724	10.400
--------	--------

**End Ladder 180/2, galv.**  
As access for PERI Formwork Systems.

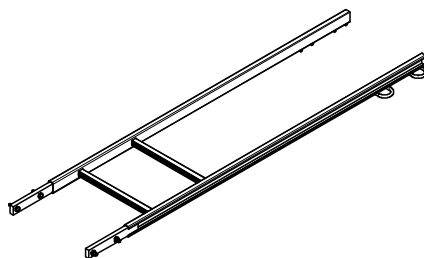

**Complete with**  
4 pc. 710224 Bolt ISO 4017 M12 x 40-8.8, galv.  
4 pc. 710381 Nut ISO 7042 M12-8, galv.

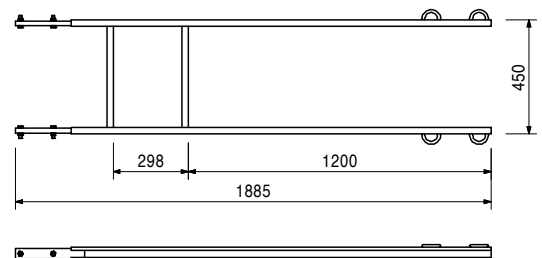

Item no.	Weight kg
051460	2.180

### Ladder Base, galv.

As bottom ladder connection and for securing ladders against sliding on the scaffold decks.

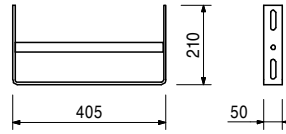
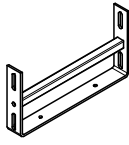

104132	15.600
051450	25.200

### Ladder Safety Cages

#### Ladder Safety Cage 75, galv.

#### Ladder Safety Cage 150, galv.

Ladder safety cage for PERI Access Ladders.

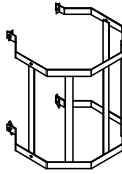

### Complete with

4 pc. 710266 Bolt ISO 4017 M12 x 25-8.8, galv.

4 pc. 701763 Clamping Plate FI 25 x 10 x 90

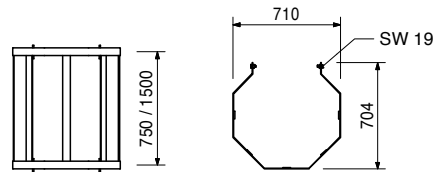

103718	0.684
--------	-------

### Ladder Hook, galv.

For adjusting the bottom ladder.  
Always use in pairs.



### Complete with

2 pc. 710266 Bolt ISO 4017 M12 x 25-8.8, galv.

2 pc. 710381 Nut ISO 7042 M12-8, galv.

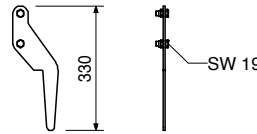

028050	4.550
--------	-------

### Girder Headpiece GT 24, galv.

For connecting push-pull props and kicker braces to GT 24 Girders

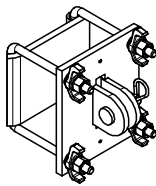

### Complete with

1 pc. 027170 Pin Ø 16 x 42, galv.

1 pc. 018060 Cotter Pin 4/1, galv.

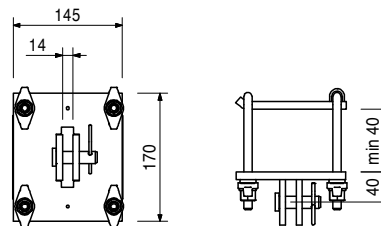

# VARIO GT 24 Girder Wall Formwork



Item no.	Weight kg
028070	4.680

## Girder Headpiece GT 24/A, galv.

For connecting push-pull props and kicker braces to extended GT 24 Girders in the area of the Extension Splice 24-2.

## Complete with

1 pc. 027170 Pin Ø 16 x 42, galv.  
1 pc. 018060 Cotter Pin 4/1, galv.

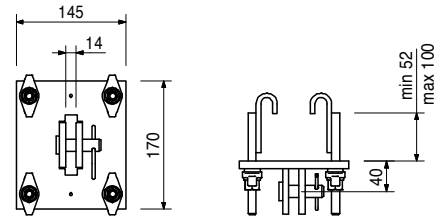
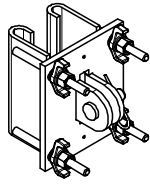

028060	1.940
--------	-------

## Wedge Headpiece SRZ/SRU

For connecting push-pull props and kicker braces to Steel Waler SRZ and SRU Profile U100 – U140.

## Complete with

1 pc. 027170 Pin Ø 16 x 42, galv.  
1 pc. 018060 Cotter Pin 4/1, galv.

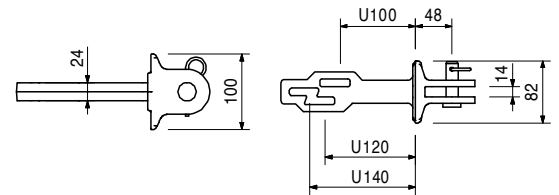
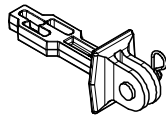

Accessories

024250	0.331
--------	-------

## Wedge K, galv.

117466	10.600
--------	--------

## Push-Pull Prop RS 210, galv.

Extension length  $l = 1.30 - 2.10$  m.  
For aligning PERI Formwork Systems and precast concrete elements.

## Note

Permissible load see PERI Design Tables.

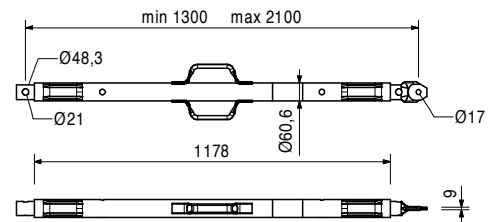
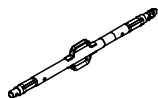

118238	12.100
--------	--------

## Push-Pull Prop RS 260, galv.

Extension length  $l = 2.30 - 2.60$  m.  
For aligning PERI Formwork Systems and precast concrete elements.

## Note

Permissible load see PERI Design Tables.

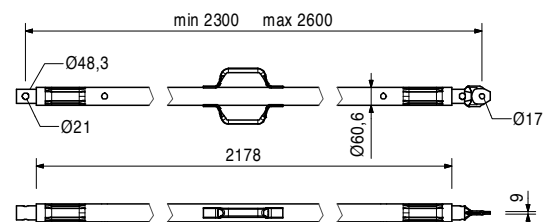
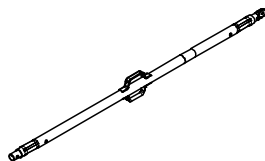

# VARIO GT 24 Girder Wall Formwork



Item no.	Weight kg
117467	15.500

## Push-Pull Prop RS 300, galv.

Extension length  $l = 1.90 - 3.00$  m.  
For aligning PERI Formwork Systems and precast concrete elements.

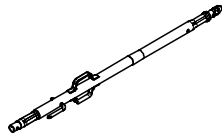

### Note

Permissible load see PERI Design Tables.

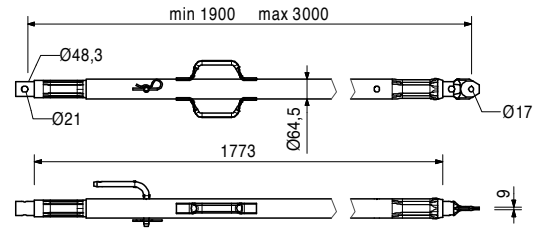

117468	23.000
--------	--------

## Push-Pull Prop RS 450, galv.

Extension length  $l = 2.80 - 4.50$  m.  
For aligning PERI Formwork Systems and precast concrete elements.

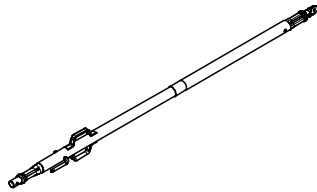

### Note

Permissible load see PERI Design Tables.

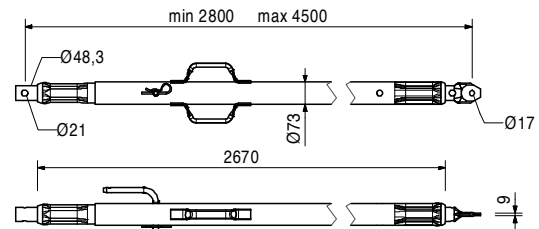

117469	39.900
--------	--------

## Push-Pull Prop RS 650, galv.

Extension length  $l = 4.30 - 6.50$  m.  
For aligning PERI formwork systems and precast concrete elements.

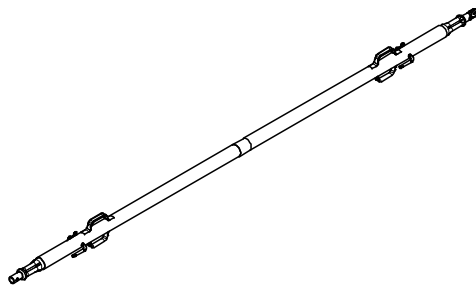

### Note

Permissible load see PERI Design Tables.

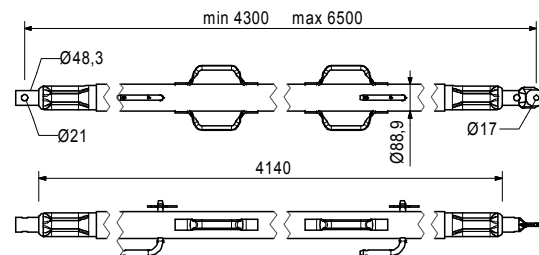

028990	115.000
--------	---------

## Push-Pull Prop RS 1000, galv.

Extension length  $l = 6.40 - 10.00$  m.  
For aligning PERI formwork systems.

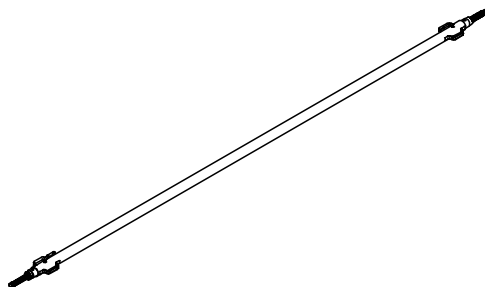

### Note

Permissible load see PERI Design Tables.

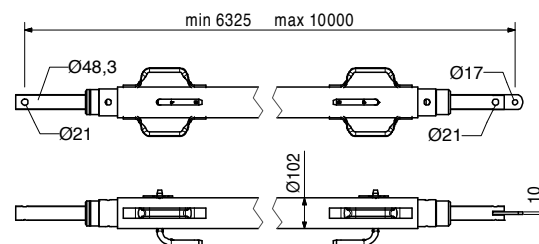

# VARIO GT 24 Girder Wall Formwork



Item no.	Weight kg
103800	271.000

**Push-Pull Prop RS 1400, galv.**  
 Extension length  $l = 6.40 - 14.00$  m.  
 For aligning PERI formwork systems.

**Note**  
 Permissible load see PERI Design Tables.  
 Chain can be operated from bottom.

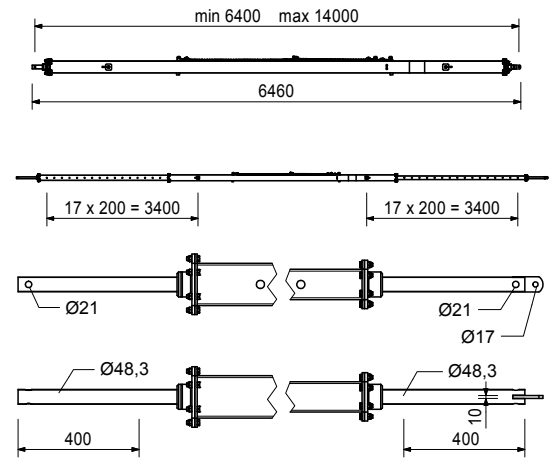
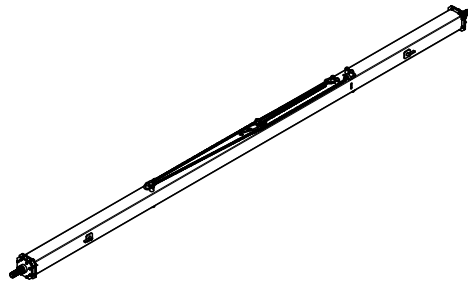

126666	3.070
--------	-------

**Base Plate-3 for RS 210 - 1400**  
 For assembly of Push-Pull Props RS 210, 260, 300, 450, 650, 1000 and 1400.

**Complete with**  
 2 pc. 105400 Pin  $\varnothing 20 \times 140$ , galv.  
 2 pc. 018060 Cotter Pin 4/1, galv.  
 1 pc. 113063 Bolt ISO 4014 M12  $\times 80-8.8$ , galv.  
 1 pc. 113064 Hex Nut ISO7042-M12-8-G, galv.

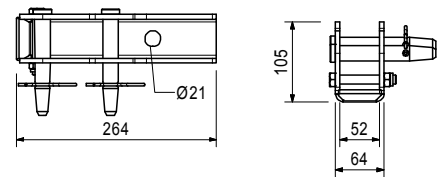
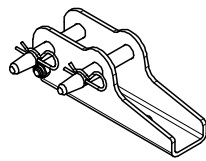

Accessories

124777	0.210
--------	-------

**Anchor Bolt PERI 14/20 x 130**

102018	4.880
--------	-------

**Base Plate-2 for RS 1000/1400, galv.**  
 For assembly of Push-Pull Props RS 210, 260, 300, 450, 650, 1000, 1400 and Heavy Duty Spindles.

**Complete with**  
 2 pc. 105400 Pin  $\varnothing 20 \times 140$ , galv.  
 2 pc. 018060 Cotter Pin 4/1, galv.

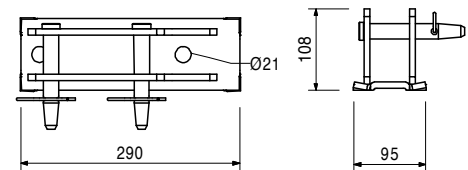
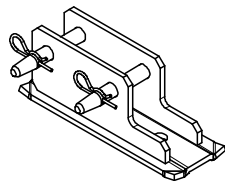

Item no.	Weight kg
117343	3.250

**Base Plate-2 for RS 210 - 1400, galv.**  
For assembly of Push-Pull Props RS 210, 260, 300, 450, 650, 1000 and 1400.

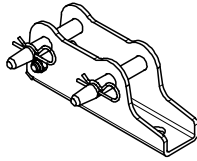

**Complete with**  
2 pc. 105400 Pin Ø 20 x 140, galv.  
2 pc. 018060 Cotter Pin 4/1, galv.

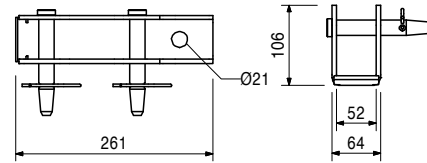

Accessories

124777	0.210
--------	-------

**Anchor Bolt PERI 14/20 x 130**

028010	17.900
--------	--------

**Push-Pull Prop RSS I**  
Extension length l = 2.05 – 2.94 m.  
For aligning PERI Formwork Systems.

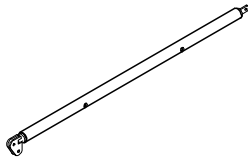

**Note**  
Permissible load see PERI Design Tables.

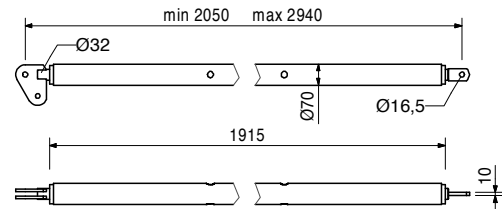

Accessories

113397	1.600
--------	-------

**Spindle Handle RSS / AV**

113397	1.600
--------	-------

**Spindle Handle RSS / AV**  
Spindle handle for screwing on Push-Pull-Props RSS I, RSS II and Kickers AV 210 and AV RSS III.

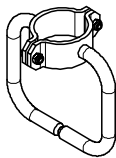

**Complete with**  
2 pc. 722342 Screw ISO 4017 M8 x 25-8.8, galv.  
2 pc. 711071 Nut ISO 7042 M8-8, galv.

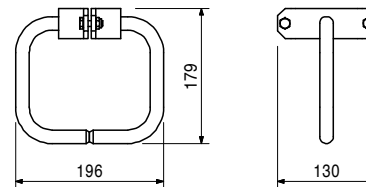

028020	22.000
--------	--------

**Push-Pull Prop RSS II**  
Extension length l = 2.91 – 3.80 m.  
For aligning PERI Formwork Systems.

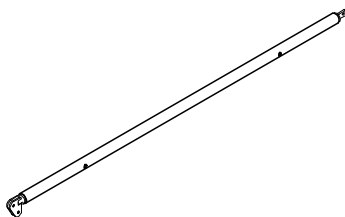

**Note**  
Permissible load see PERI Design Tables.

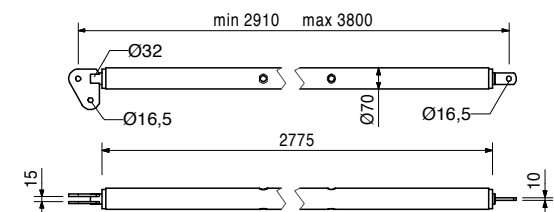

Accessories

113397	1.600
--------	-------

**Spindle Handle RSS / AV**

# VARIO GT 24 Girder Wall Formwork



Item no.	Weight kg
028030	38.400

**Push-Pull Prop RSS III**  
 Extension length l = 4.60 – 6.00 m.  
 For aligning PERI formwork systems.

**Note**  
 Permissible load see PERI Design Tables.

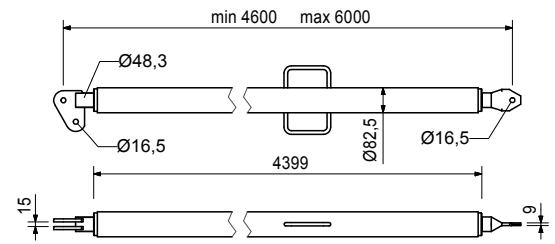
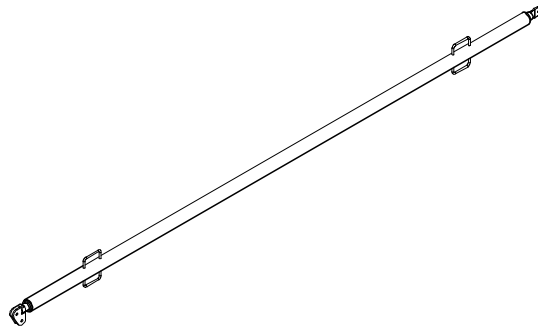

106000	1.820
--------	-------

**Base Plate-2 for RSS, galv.**  
 For assembly of Push-Pull Props RSS.

**Complete with**  
 1 pc. 027170 Pin Ø 16 x 42, galv.  
 1 pc. 018060 Cotter Pin 4/1, galv.

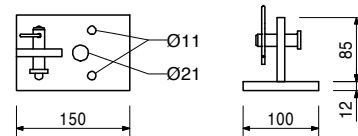
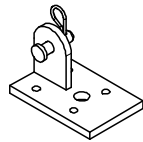

Accessories  
**Anchor Bolt PERI 14/20 x 130**

124777	0.210
--------	-------

057087	3.510
057088	4.200

**Kickers AV**  
**Kicker AV 82**  
**Kicker AV 111**  
 For aligning PERI Formwork Systems.

min. L	max. L
500	820
790	1110

**Complete with**  
 1 pc. 027170 Pin Ø 16 x 42, galv.  
 1 pc. 018060 Cotter Pin 4/1, galv.

**Note**  
 Permissible load see PERI Design Tables.

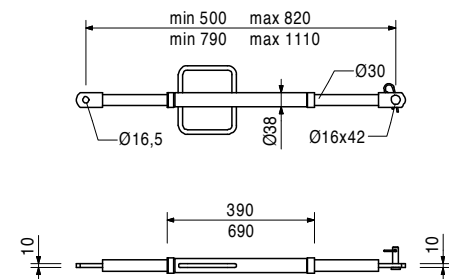
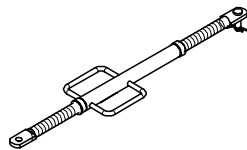

Item no.	Weight kg
028110	4.850

**Kicker AV 140**  
 Extension length  $l = 1.08 - 1.40$  m.  
 For aligning PERI Formwork Systems.

**Complete with**  
 1 pc. 027170 Pin  $\varnothing 16 \times 42$ , galv.  
 1 pc. 018060 Cotter Pin 4/1, galv.

**Note**  
 Permissible load see PERI Design Tables.

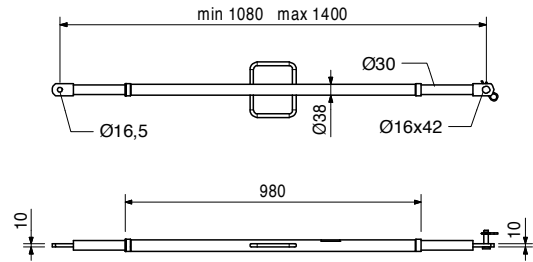
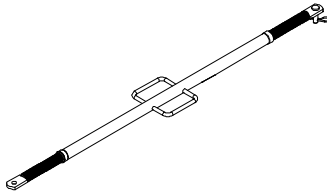

028120	17.000
--------	--------

**Kicker AV RSS III**  
 Extension length  $l = 2.03 - 2.92$  m.  
 For aligning PERI formwork systems.

**Complete with**  
 1 pc. 027170 Pin  $\varnothing 16 \times 42$ , galv.  
 1 pc. 018060 Cotter Pin 4/1, galv.

**Note**  
 Permissible load see PERI Design Tables.

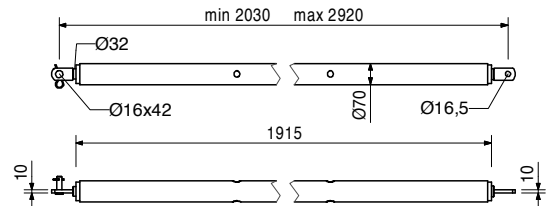
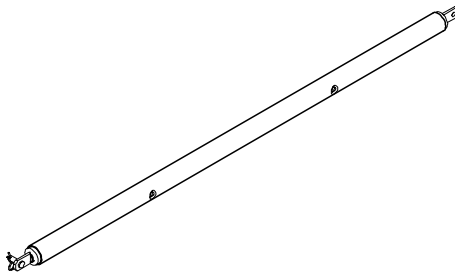

Accessories

113397	1.600
--------	-------

**Spindle Handle RSS / AV**

108135	12.900
--------	--------

**Kicker AV 210**  
 Extension length  $l = 1.28 - 2.10$  m.  
 For aligning PERI Formwork Systems.

**Complete with**  
 1 pc. 027170 Pin  $\varnothing 16 \times 42$ , galv.  
 1 pc. 018060 Cotter Pin 4/1, galv.

**Note**  
 Permissible load see PERI Design Tables.

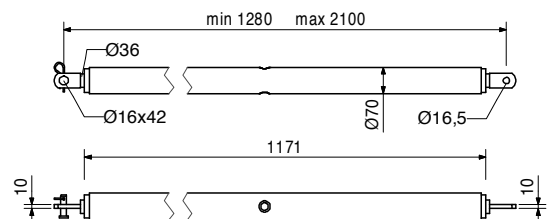
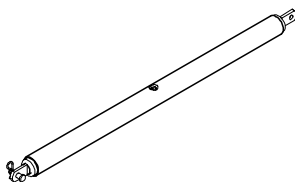

Accessories

113397	1.600
--------	-------

**Spindle Handle RSS / AV**

Item no.	Weight kg
028080	2.970

**Connector Kicker/Push-Pull Prop, galv.**

For connecting push-pull props and kicker braces to Main Beam HDT.

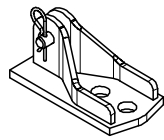

**Complete with**

1 pc. 018060 Cotter Pin 4/1, galv.  
1 pc. 027170 Pin Ø 16 x 42, galv.

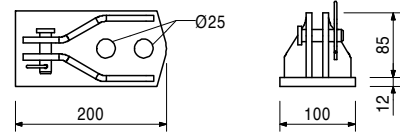

124777	0.210
--------	-------

**Anchor Bolt PERI 14/20 x 130**

For temporary fixation to reinforced concrete structures.

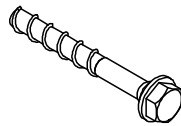

**Note**

See PERI data sheet!  
Drilling Ø 14 mm.

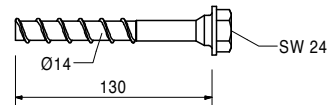





# PERI International

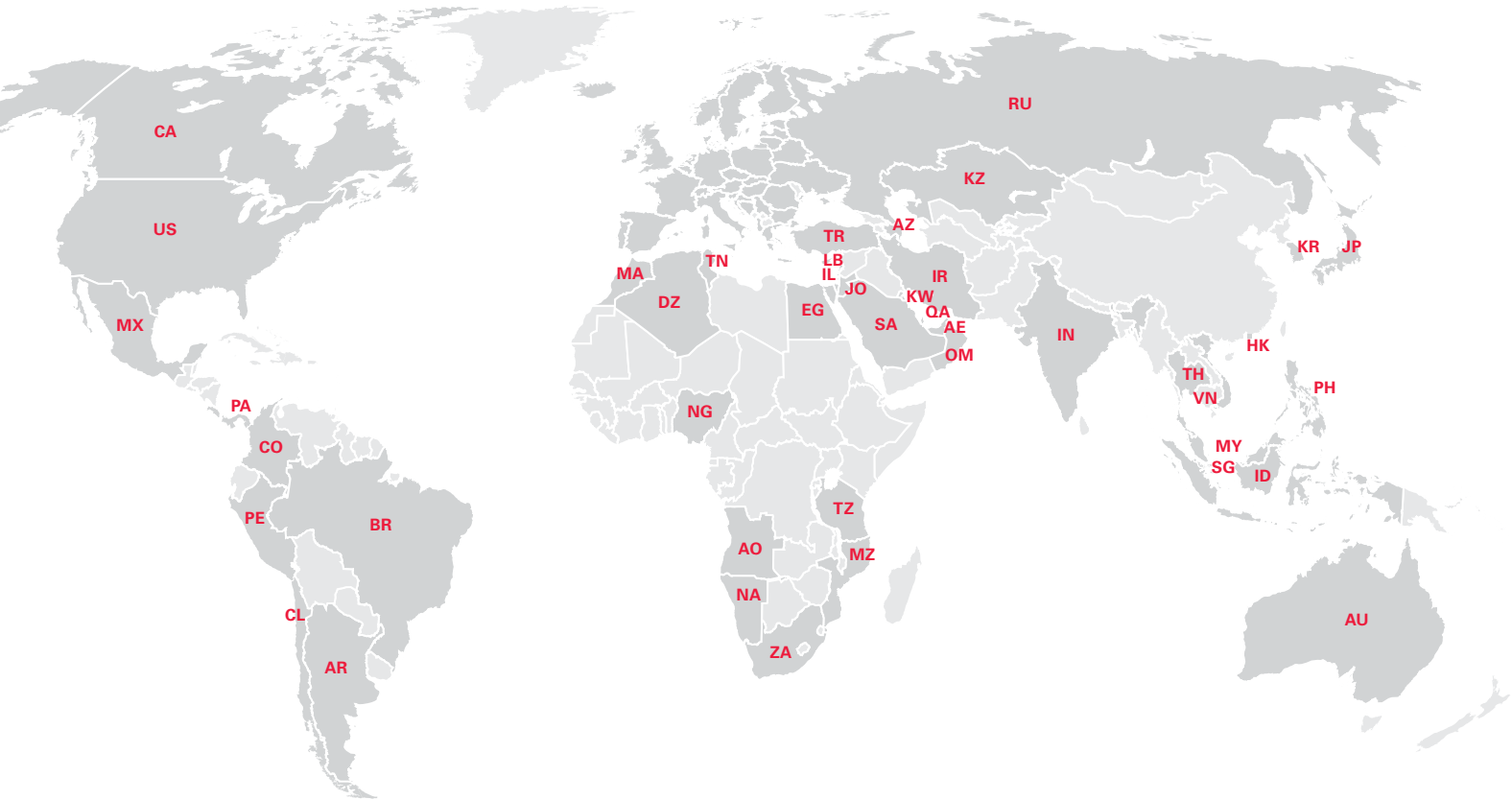

## North America

- CA** Canada  
PERI Formwork Systems, Inc.  
[www.peri.ca](http://www.peri.ca)
- MX** Mexico  
PERI Cimbras y Andamios, S.A. de C.V.  
[www.peri.com.mx](http://www.peri.com.mx)
- PA** Panama  
PERI Panama Inc.  
[www.peri.com.pa](http://www.peri.com.pa)
- US** USA  
PERI Formwork Systems, Inc.  
[www.peri-usa.com](http://www.peri-usa.com)

## South America

- AR** Argentina  
PERI S.A.  
[www.peri.com.ar](http://www.peri.com.ar)
- BR** Brazil  
PERI Formas e Escoramentos Ltda.  
[www.peribrasil.com.br](http://www.peribrasil.com.br)
- CL** Chile  
PERI Chile Ltda.  
[www.peri.cl](http://www.peri.cl)
- CO** Colombia  
PERI S.A.S.  
[www.peri.com.co](http://www.peri.com.co)
- PE** Peru  
PERI Peruana S.A.C.  
[www.peri.com.pe](http://www.peri.com.pe)

## Africa

- AO** Angola  
Pericofragens, Lda.  
[www.peri.pt](http://www.peri.pt)
- DZ** Algeria  
S.A.R.L. PERI  
[www.peri.dz](http://www.peri.dz)
- EG** Egypt  
Egypt Branch Office  
[www.peri.com.eg](http://www.peri.com.eg)
- MA** Morocco  
PERI S.A.  
[www.peri.ma](http://www.peri.ma)
- MZ** Mozambique  
PERI (Pty.) Ltd.  
[www.peri.co.mz](http://www.peri.co.mz)
- NA** Namibia  
PERI (Pty.) Ltd.  
[www.peri.na](http://www.peri.na)
- NG** Nigeria  
PERI Nigeria Ltd.  
[www.peri.ng](http://www.peri.ng)
- TN** Tunisia  
PERI S.A.U.  
[www.peri.es](http://www.peri.es)
- TZ** Tanzania  
PERI Formwork and Scaffolding Ltd  
[www.peri.co.tz](http://www.peri.co.tz)
- ZA** South Africa  
PERI Formwork Scaffolding (Pty) Ltd  
[www.peri.co.za](http://www.peri.co.za)

## Asia

- AE** United Arab Emirates  
PERI (L.L.C.)  
[www.peri.ae](http://www.peri.ae)
- AZ** Azerbaijan  
PERI Representative Office  
[www.peri.com.tr](http://www.peri.com.tr)
- HK** Hong Kong  
PERI (Hong Kong) Limited  
[www.perihk.com](http://www.perihk.com)
- ID** Indonesia  
PT Beton Perkasa Wijaksana  
[www.betonperkasa.com](http://www.betonperkasa.com)
- IL** Israel  
PERI F.E. Ltd.  
[www.peri.co.il](http://www.peri.co.il)
- IN** India  
PERI (India) Pvt Ltd  
[www.peri.in](http://www.peri.in)
- IR** Iran  
PERI Pars. Ltd.  
[www.peri.ir](http://www.peri.ir)
- JO** Jordan  
PERI GmbH – Jordan  
[www.peri.com](http://www.peri.com)
- JP** Japan  
PERI Japan K.K.  
[www.peri.co.jp](http://www.peri.co.jp)
- KR** Korea  
PERI (Korea) Ltd.  
[www.perikorea.com](http://www.perikorea.com)
- KW** Kuwait  
PERI Kuwait W.L.L.  
[www.peri.com.kw](http://www.peri.com.kw)
- KZ** Kazakhstan  
TOO PERI Kazakhstan  
[www.peri.kz](http://www.peri.kz)
- LB** Lebanon  
PERI Lebanon Sarl  
[lebanon@peri.de](mailto:lebanon@peri.de)
- MY** Malaysia  
PERI Formwork Malaysia Sdn. Bhd.  
[www.perimalaysia.com](http://www.perimalaysia.com)
- OM** Oman  
PERI (L.L.C.)  
[www.peri.ae](http://www.peri.ae)
- PH** Philippines  
PERI-Asia Philippines, INC.  
[www.peri.com.ph](http://www.peri.com.ph)
- QA** Qatar  
PERI Qatar LLC  
[www.peri.qa](http://www.peri.qa)
- SA** Saudi Arabia  
PERI Saudi Arabia Ltd.  
[www.peri.com.sa](http://www.peri.com.sa)
- SG** Singapore  
PERI Asia Pte Ltd  
[www.periasia.com](http://www.periasia.com)
- TH** Thailand  
Peri (Thailand) Co., Ltd.  
[www.peri.co.th](http://www.peri.co.th)
- TR** Turkey  
PERI Kalıp ve İskeleleri  
[www.peri.com.tr](http://www.peri.com.tr)
- VN** Vietnam  
PERI ASIA PTE LTD  
[www.peri.com.vn](http://www.peri.com.vn)



**PERI**

**PERI GmbH  
Formwork Scaffolding Engineering**

Rudolf-Diesel-Strasse 19  
89264 Weissenhorn  
Germany  
Tel. +49 (0)7309.950-0  
Fax +49 (0)7309.951-0  
info@peri.com  
www.peri.com

**Oceania**

**AU** Australia  
PERI Australia Pty. Ltd.  
www.periaus.com.au

**DK** Denmark  
PERI Danmark A/S  
www.peri.dk

**IT** Italy  
PERI S.r.l.  
www.peri.it

**SE** Sweden  
PERI Sverige AB  
www.peri.se

**Europe**

**EE** Estonia  
PERI AS  
www.peri.ee

**LT** Lithuania  
PERI UAB  
www.peri.lt

**SI** Slovenia  
PERI oplate i skele d.o.o  
www.peri.com.hr

**AL** Albania  
PERI Kalıp ve İskeleleri  
www.peri.com.tr

**ES** Spain  
PERI S.A.U.  
www.peri.es

**LU** Luxembourg  
N.V. PERI S.A.  
www.peri.lu

**SK** Slovakia  
PERI spol. s. r.o.  
www.peri.sk

**AT** Austria  
PERI Ges.mbh  
www.peri.at

**FI** Finland  
PERI Suomi Ltd. Oy  
www.perisuomi.fi

**LV** Latvia  
PERI SIA  
www.peri-latvija.lv

**UA** Ukraine  
TOW PERI  
www.peri.ua

**BA** Bosnia and Herzegovina  
PERI oplate i skele d.o.o  
www.peri.com.hr

**FR** France  
PERI S.A.S.  
www.peri.fr

**NL** Netherlands  
PERI b.v.  
www.peri.nl

**BE** Belgium  
PERI N.V.  
www.peri.be

**GB** United Kingdom  
PERI Ltd.  
www.peri.ltd.uk

**NO** Norway  
PERI Norge AS  
www.peri.no

**BG** Bulgaria  
PERI Bulgaria EOOD  
www.peri.bg

**GR** Greece  
PERI Hellas Ltd.  
www.perihellas.gr

**PL** Poland  
PERI Polska Sp. z o.o.  
www.peri.com.pl

**BY** Belorussia  
IOOO PERI  
www.peri.by

**HR** Croatia  
PERI oplate i skele d.o.o.  
www.peri.com.hr

**PT** Portugal  
Pericofragens Lda.  
www.peri.pt

**CH** Switzerland  
PERI AG  
www.peri.ch

**HU** Hungary  
PERI Kft.  
www.peri.hu

**RO** Romania  
PERI România SRL  
www.peri.ro

**CZ** Czech Republic  
PERI spol. s r.o.  
www.peri.cz

**IR** Ireland  
Siteserv Access & Formwork  
www.siteservaccess.ie

**RS** Serbia  
PERI oplate d.o.o.  
www.peri.rs

**DE** Germany  
PERI GmbH  
www.peri.de

**IS** Iceland  
Armar ehf.  
www.armor.is

**RU** Russia  
OOO PERI  
www.peri.ru

**The optimal System  
for every Project and  
every Requirement**



**Wall Formwork**



**Column Formwork**



**Slab Formwork**



**Climbing Systems**



**Bridge Formwork**



**Tunnel Formwork**



**Shoring Systems**



**Construction Scaffold**



**Facade Scaffold**



**Industrial Scaffold**



**Access**



**Protection Scaffold**



**Safety Systems**



**System-Independent Accessories**



**Services**



**PERI GmbH**  
**Formwork Scaffolding Engineering**  
 Rudolf-Diesel-Strasse 19  
 89264 Weissenhorn  
 Germany  
 Tel. +49 (0)7309.950-0  
 Fax +49 (0)7309.951-0  
 info@peri.com  
 www.peri.com